

# 南京诺金电气有限公司

## Nanjing Nowking Electric Co., Ltd

### 塑料铜柱



### 塑料铜柱

PART NO: KHPL-01

- ◆ MATERIAL: NYLON 66 (UL)
- ◆ FLAME CLASS :94V-2/94V-0
- ◆ COLOR: NATURAL
- ◆ UNIT: mm

用于: 做为 PC 板与机板间之固定, 六角型不滑动。

KHPL-01 结构图

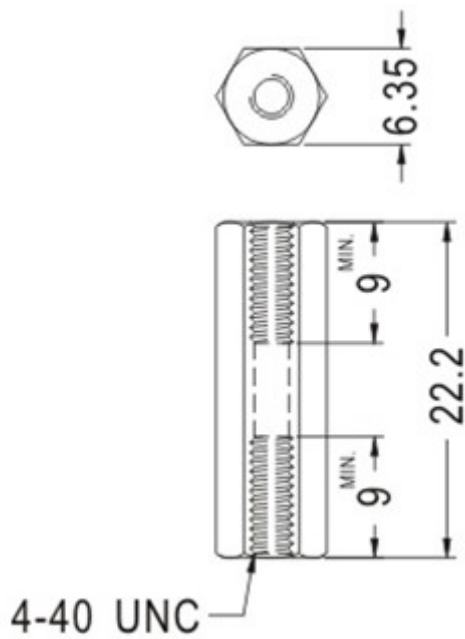

PART NO	A	B	PACKAGE
KHPL-01	22.2	9.0	1000

# 南京诺金电气有限公司

## Nanjing Nowking Electric Co., Ltd



### 塑料铜柱

PART NO: KHPL-02

- ◆ MATERIAL: NYLON 66 (UL)
- ◆ FLAME CLASS : 94V-2/94V-0
- ◆ COLOR: NATURAL
- ◆ UNIT: mm

用于: 做为 PC 板与机板间之固定, 六角型不滑动。

KHPL-02 结构图

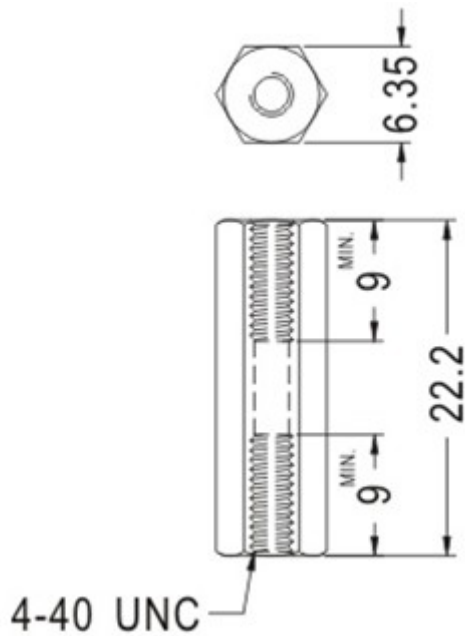

PART NO	A	B	PACKAGE
KHPL-02	28.6	6.4	1000



塑料铜柱

PART NO: KHPL-03

- ◆ MATERIAL: NYLON 66 (UL)
- ◆ FLAME CLASS: 94V-2
- ◆ COLOR: NATURAL
- ◆ UNIT: mm

用途: 做为 PC 板与机板间之固定。

KHPL-03 结构图

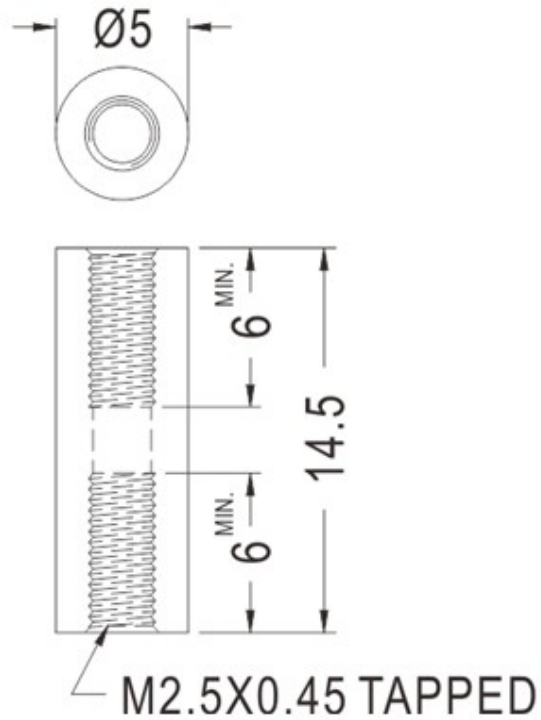

**PART NO**  
KHPL-03

**PACKAGE**  
1000

# 南京诺金电气有限公司

## Nanjing Nowking Electric Co., Ltd

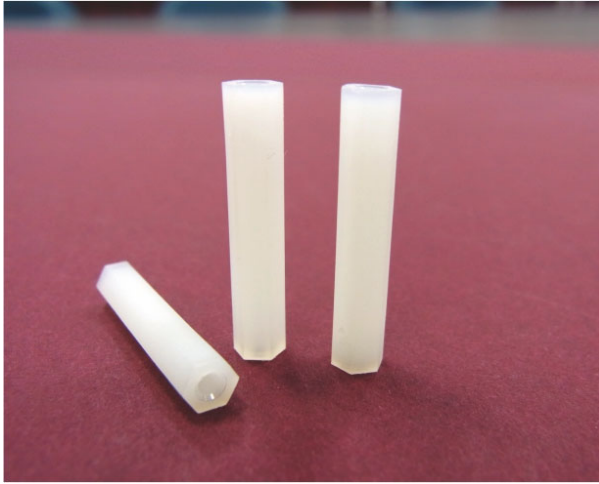

### 塑料铜柱

PART NO: KHPL-04

- ◆ MATERIAL: NYLON 66 (UL)
- ◆ FLAME CLASS :94V-2/94V-0
- ◆ COLOR: NATURAL
- ◆ UNIT: mm

用途: 做为 PC 板与机板间之固定,  
六角型不滑动。

KHPL-04 结构图

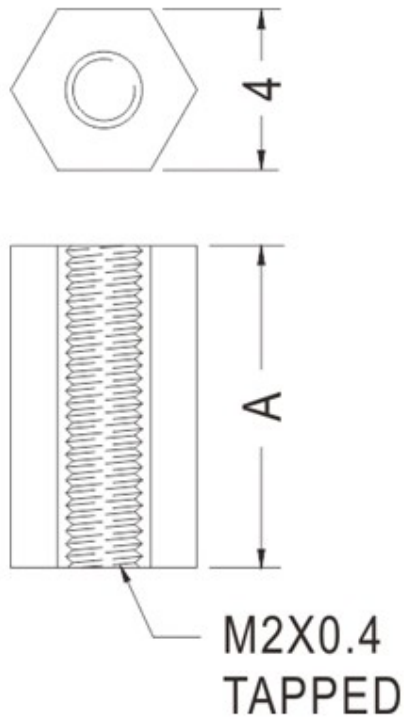

PART NO	A	PACKAGE
KHPL-04	4.0	1000

# 南京诺金电气有限公司

## Nanjing Nowking Electric Co., Ltd

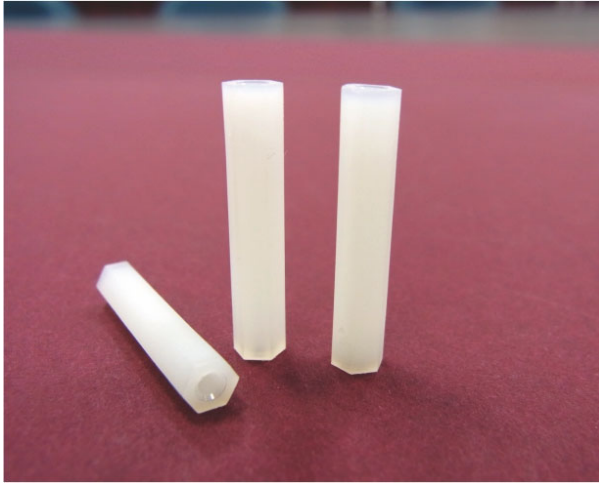

### 塑料铜柱

PART NO: KHPL-05

- ◆ MATERIAL: NYLON 66 (UL)
- ◆ FLAME CLASS :94V-2/94V-0
- ◆ COLOR: NATURAL
- ◆ UNIT: mm

用途: 做为 PC 板与机板间之固定,  
六角型不滑动。

KHPL-05 结构图

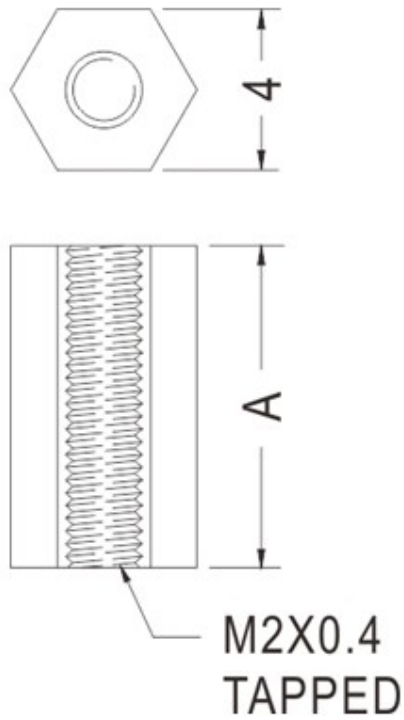

PART NO	A	PACKAGE
KHPL-05	5.0	1000

# 南京诺金电气有限公司

## Nanjing Nowking Electric Co., Ltd

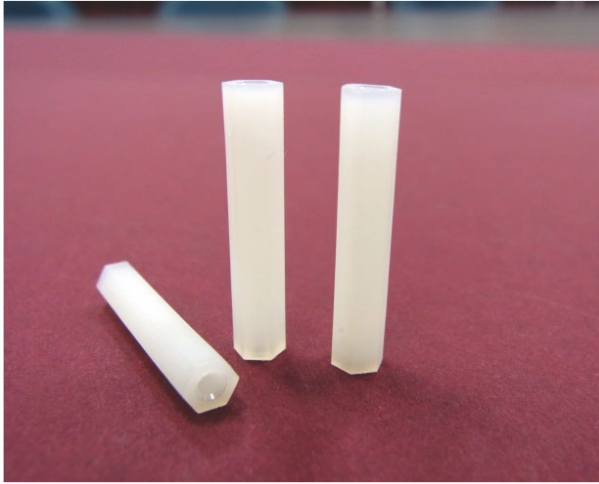

### 塑料铜柱

PART NO: KHPL-06

- ◆ MATERIAL: NYLON 66 (UL)
- ◆ FLAME CLASS :94V-2/94V-0
- ◆ COLOR: NATURAL
- ◆ UNIT: mm

用途: 做为 PC 板与机板间之固定,  
六角型不滑动。

KHPL-06 结构图

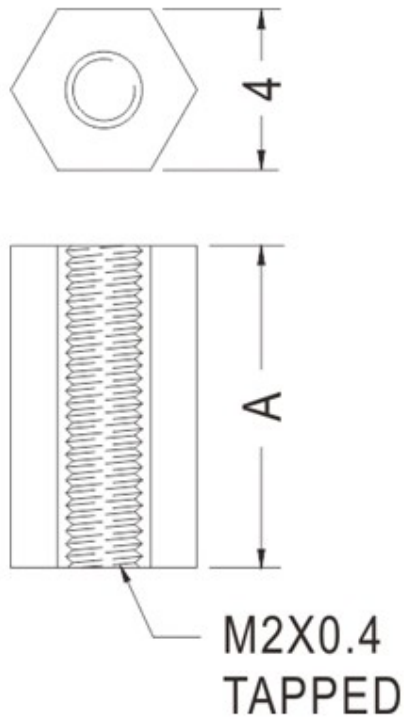

PART NO	A	PACKAGE
KHPL-06	6.0	1000

# 南京诺金电气有限公司

## Nanjing Nowking Electric Co., Ltd

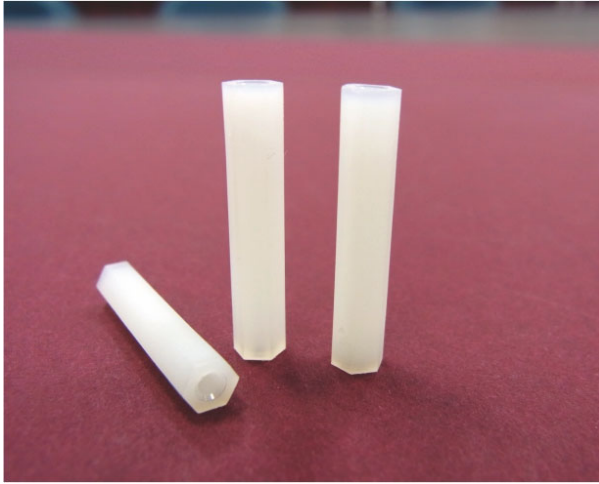

### 塑料铜柱

PART NO: KHPL-07

- ◆ MATERIAL: NYLON 66 (UL)
- ◆ FLAME CLASS :94V-2/94V-0
- ◆ COLOR: NATURAL
- ◆ UNIT: mm

用途: 做为 PC 板与机板间之固定,  
六角型不滑动。

KHPL-07 结构图

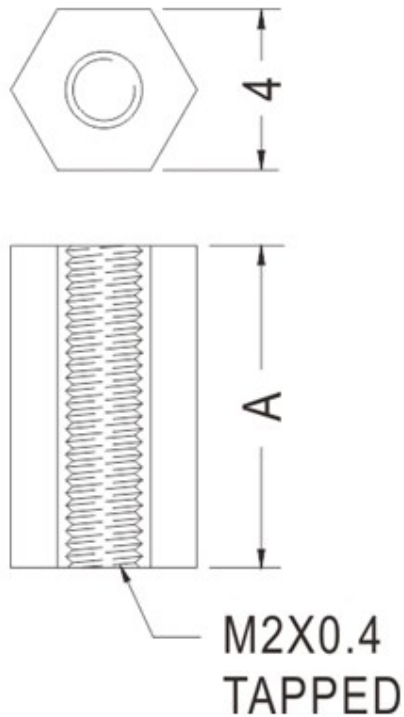

PART NO	A	PACKAGE
KHPL-07	7.0	1000

# 南京诺金电气有限公司

## Nanjing Nowking Electric Co., Ltd

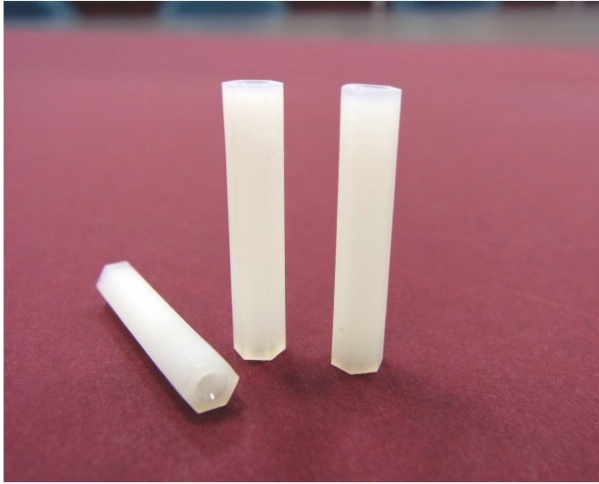

### 塑料铜柱

PART NO: KHPL-08

- ◆ MATERIAL: NYLON 66 (UL)
- ◆ FLAME CLASS :94V-2/94V-0
- ◆ COLOR: NATURAL
- ◆ UNIT: mm

用途: 做为 PC 板与机板间之固定,  
六角型不滑动。

KHPL-08 结构图

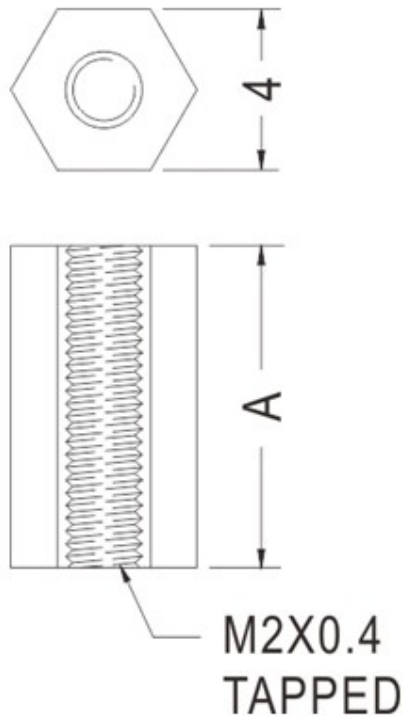

PART NO	A	PACKAGE
KHPL-08	8.0	1000



# 南京诺金电气有限公司

## Nanjing Nowking Electric Co., Ltd



### 塑料铜柱

PART NO: KHPL-09

- ◆ MATERIAL: NYLON 66 (UL)
- ◆ FLAME CLASS :94V-2/94V-0
- ◆ COLOR: NATURAL
- ◆ UNIT: mm

用途: 做为 PC 板与机板间之固定,  
六角型不滑动。

KHPL-09 结构图

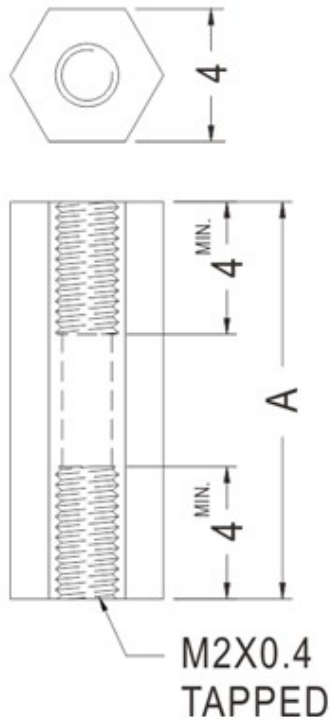

PART NO	A	PACKAGE
KHPL-09	9.0	1000

# 南京诺金电气有限公司

## Nanjing Nowking Electric Co., Ltd

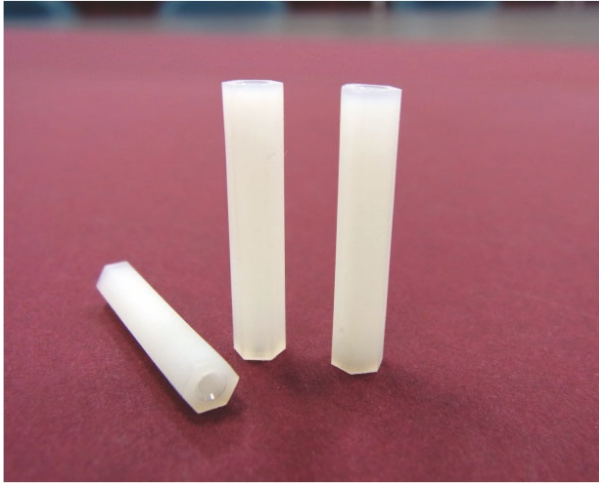

### 塑料铜柱

PART NO: KHPL-10

- ◆ MATERIAL: NYLON 66 (UL)
- ◆ FLAME CLASS :94V-2/94V-0
- ◆ COLOR: NATURAL
- ◆ UNIT: mm

用途: 做为 PC 板与机板间之固定,  
六角型不滑动。

KHPL-10 结构图

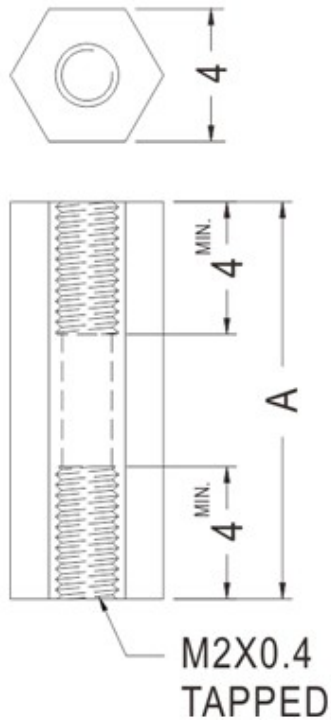

PART NO	A	PACKAGE
KHPL-10	10.0	1000

# 南京诺金电气有限公司

## Nanjing Nowking Electric Co., Ltd

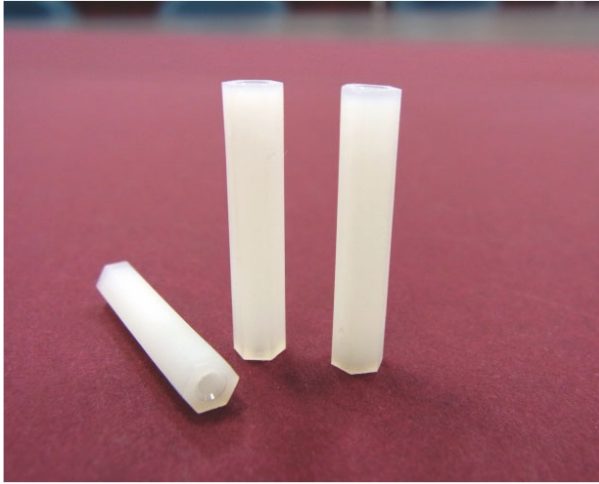

### 塑料铜柱

PART NO: KHPL-11

- ◆ MATERIAL: NYLON 66 (UL)
- ◆ FLAME CLASS :94V-2/94V-0
- ◆ COLOR: NATURAL
- ◆ UNIT: mm

用途: 做为 PC 板与机板间之固定,  
六角型不滑动。

KHPL-11 结构图

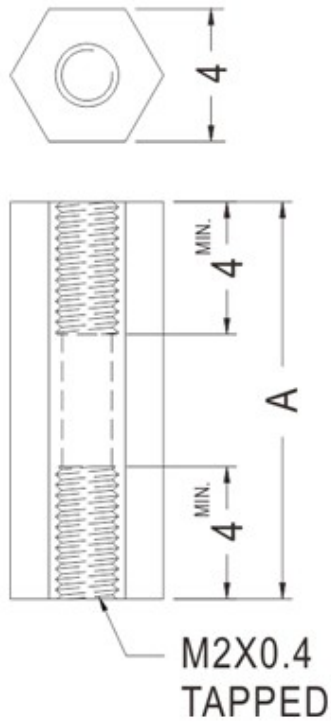

PART NO	A	PACKAGE
KHPL-11	11.0	1000

# 南京诺金电气有限公司

## Nanjing Nowking Electric Co., Ltd

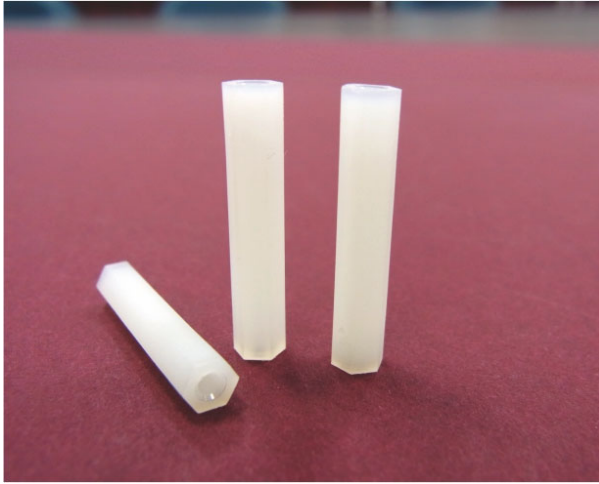

### 塑料铜柱

PART NO: KHPL-12

- ◆ MATERIAL: NYLON 66 (UL)
- ◆ FLAME CLASS :94V-2/94V-0
- ◆ COLOR: NATURAL
- ◆ UNIT: mm

用途: 做为 PC 板与机板间之固定,  
六角型不滑动。

KHPL-12 结构图

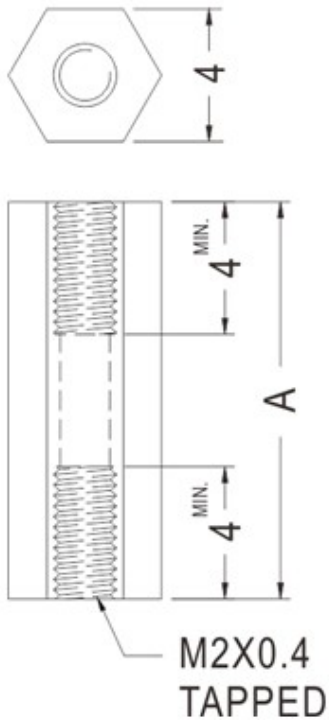

PART NO	A	PACKAGE
KHPL-12	12.0	1000

# 南京诺金电气有限公司

## Nanjing Nowking Electric Co., Ltd



### 塑料铜柱

PART NO: KHPL-13

- ◆ MATERIAL: NYLON 66 (UL)
- ◆ FLAME CLASS :94V-2/94V-0
- ◆ COLOR: NATURAL
- ◆ UNIT: mm

用途: 做为 PC 板与机板间之固定,  
六角型不滑动。

KHPL-13 结构图

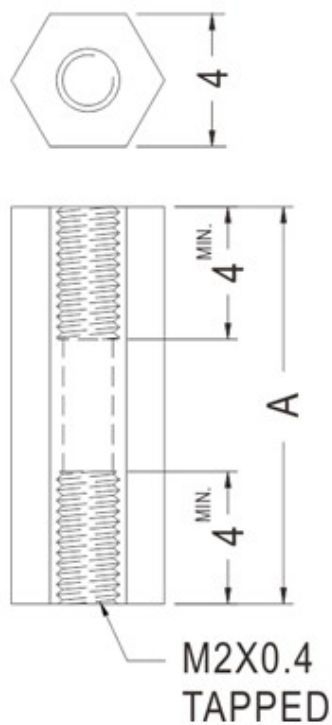

PART NO	A	PACKAGE
KHPL-13	12.7	1000

# 南京诺金电气有限公司

## Nanjing Nowking Electric Co., Ltd

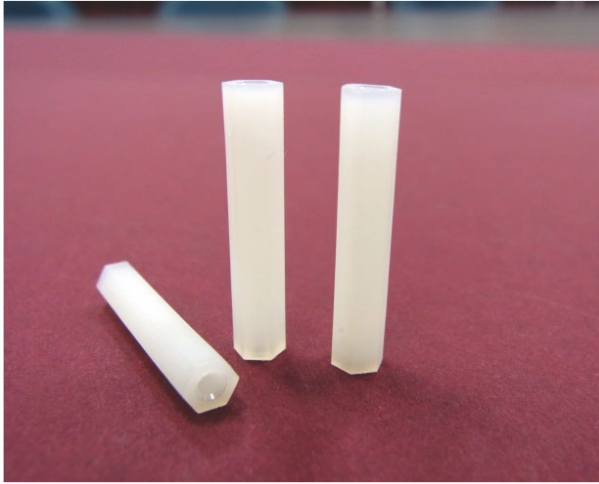

### 塑料铜柱

PART NO: KHPL-14

- ◆ MATERIAL: NYLON 66 (UL)
- ◆ FLAME CLASS :94V-2/94V-0
- ◆ COLOR: NATURAL
- ◆ UNIT: mm

用途: 做为 PC 板与机板间之固定,  
六角型不滑动。

KHPL-14 结构图

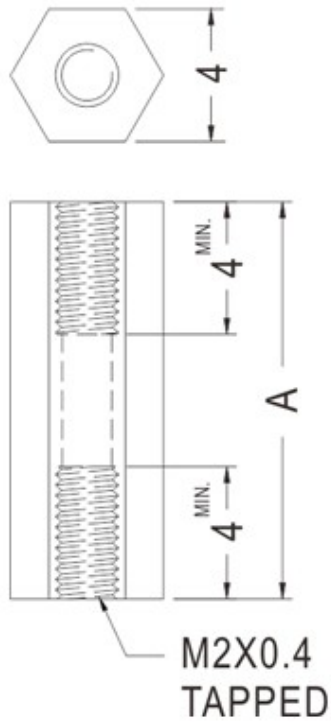

PART NO	A	PACKAGE
KHPL-14	13.0	1000

# 南京诺金电气有限公司

## Nanjing Nowking Electric Co., Ltd

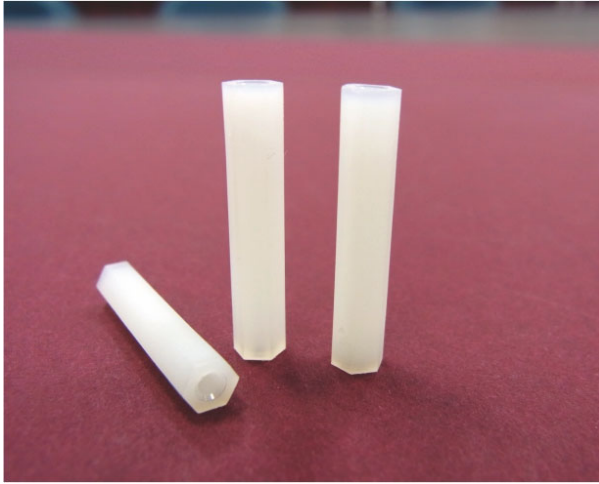

### 塑料铜柱

PART NO: KHPL-15

- ◆ MATERIAL: NYLON 66 (UL)
- ◆ FLAME CLASS :94V-2/94V-0
- ◆ COLOR: NATURAL
- ◆ UNIT: mm

用途: 做为 PC 板与机板间之固定,  
六角型不滑动。

KHPL-15 结构图

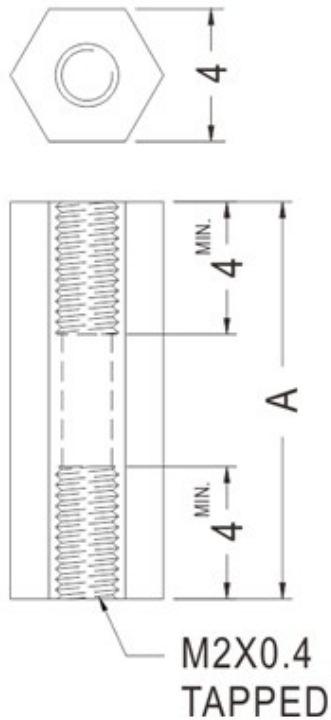

PART NO	A	PACKAGE
KHPL-15	14.0	1000

# 南京诺金电气有限公司

## Nanjing Nowking Electric Co., Ltd

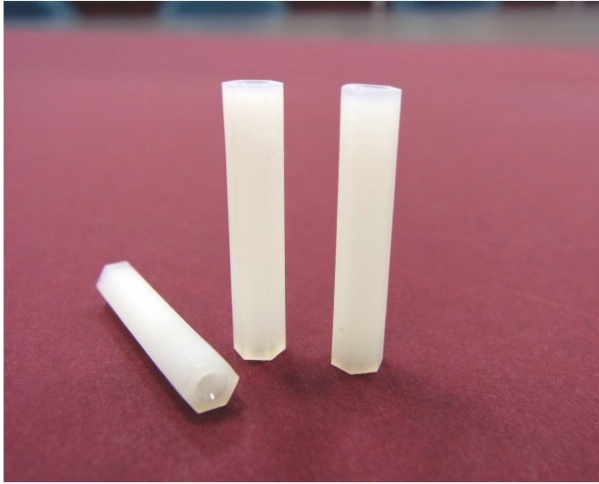

### 塑料铜柱

PART NO: KHPL-16

- ◆ MATERIAL: NYLON 66 (UL)
- ◆ FLAME CLASS :94V-2/94V-0
- ◆ COLOR: NATURAL
- ◆ UNIT: mm

用途: 做为 PC 板与机板间之固定,  
六角型不滑动。

KHPL-16 结构图

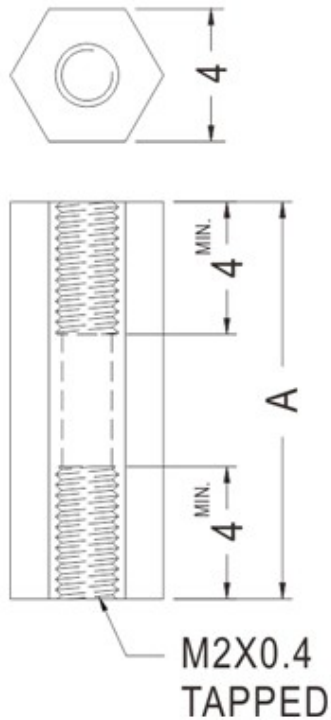

PART NO	A	PACKAGE
KHPL-16	15.0	1000



# 南京诺金电气有限公司

## Nanjing Nowking Electric Co., Ltd



### 塑料铜柱

PART NO: KHPL-17

- ◆ MATERIAL: NYLON 66 (UL)
- ◆ FLAME CLASS :94V-2/94V-0
- ◆ COLOR: NATURAL
- ◆ UNIT: mm

用途: 做为 PC 板与机板间之固定,  
六角型不滑动。

KHPL-17 结构图

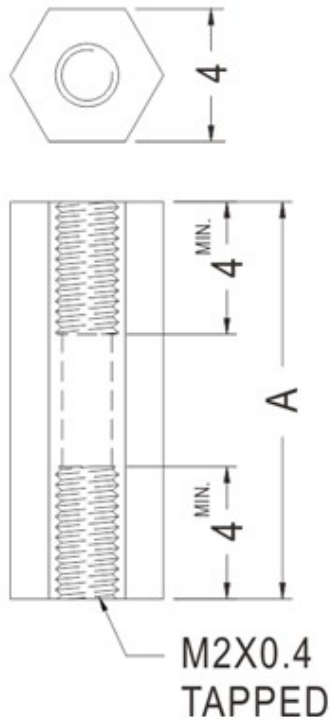

PART NO	A	PACKAGE
KHPL-17	16.0	1000

# 南京诺金电气有限公司

## Nanjing Nowking Electric Co., Ltd

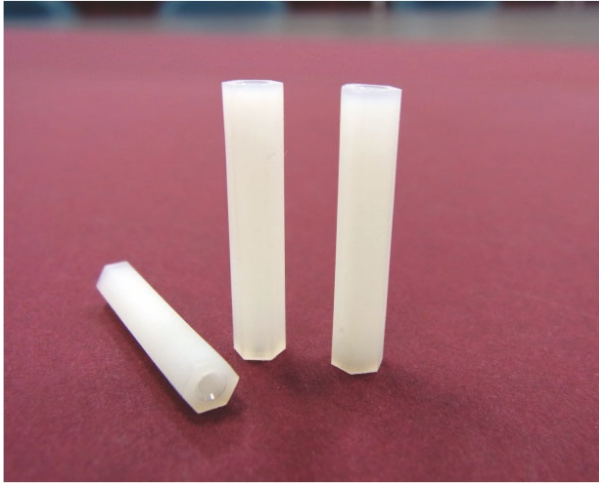

### 塑料铜柱

PART NO: KHPL-18

- ◆ MATERIAL: NYLON 66 (UL)
- ◆ FLAME CLASS :94V-2/94V-0
- ◆ COLOR: NATURAL
- ◆ UNIT: mm

用途: 做为 PC 板与机板间之固定,  
六角型不滑动。

KHPL-18 结构图

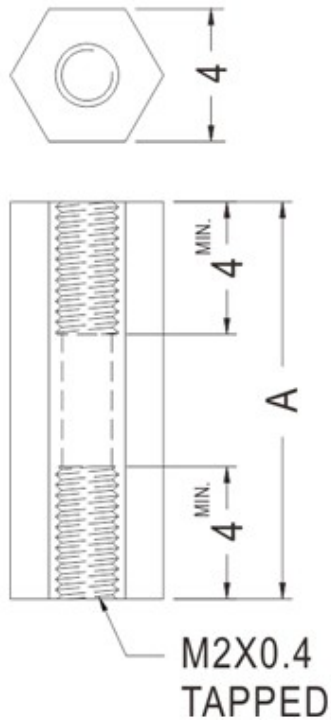

PART NO	A	PACKAGE
KHPL-18	17.0	1000

# 南京诺金电气有限公司

## Nanjing Nowking Electric Co., Ltd

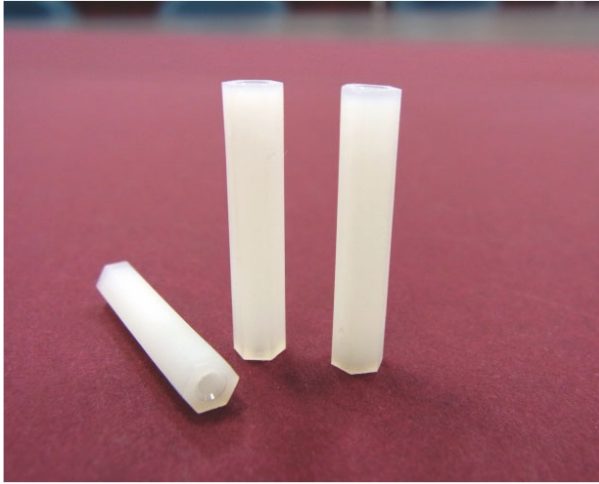

### 塑料铜柱

PART NO: KHPL-19

- ◆ MATERIAL: NYLON 66 (UL)
- ◆ FLAME CLASS :94V-2/94V-0
- ◆ COLOR: NATURAL
- ◆ UNIT: mm

用途: 做为 PC 板与机板间之固定,  
六角型不滑动。

KHPL-19 结构图

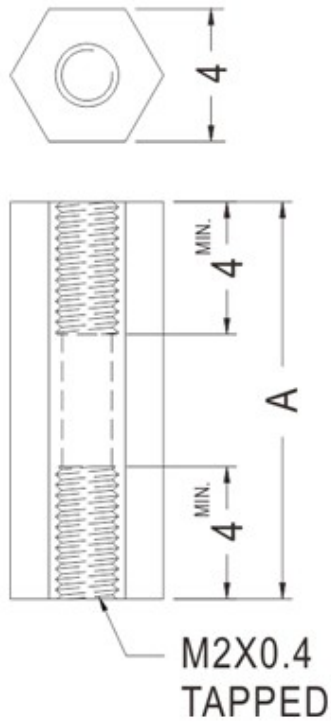

PART NO	A	PACKAGE
KHPL-19	18.0	1000

# 南京诺金电气有限公司

## Nanjing Nowking Electric Co., Ltd

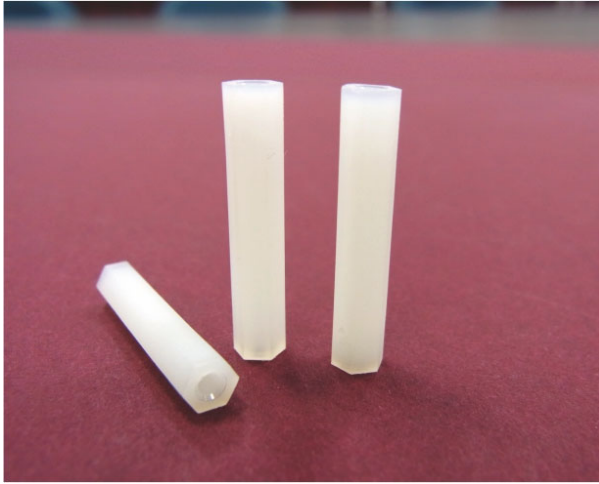

### 塑料铜柱

PART NO: KHPL-20

- ◆ MATERIAL: NYLON 66 (UL)
- ◆ FLAME CLASS :94V-2/94V-0
- ◆ COLOR: NATURAL
- ◆ UNIT: mm

用途: 做为 PC 板与机板间之固定,  
六角型不滑动。

KHPL-20 结构图

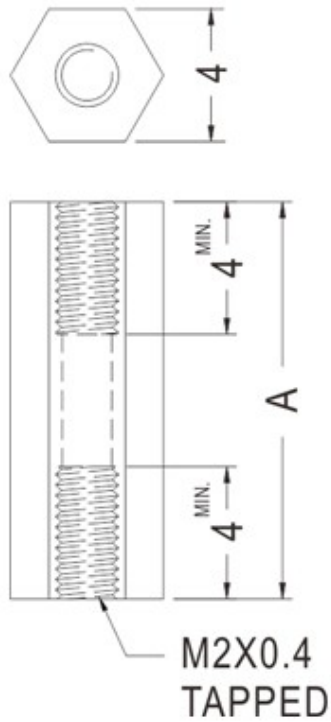

PART NO	A	PACKAGE
KHPL-20	19.0	1000

# 南京诺金电气有限公司

## Nanjing Nowking Electric Co., Ltd

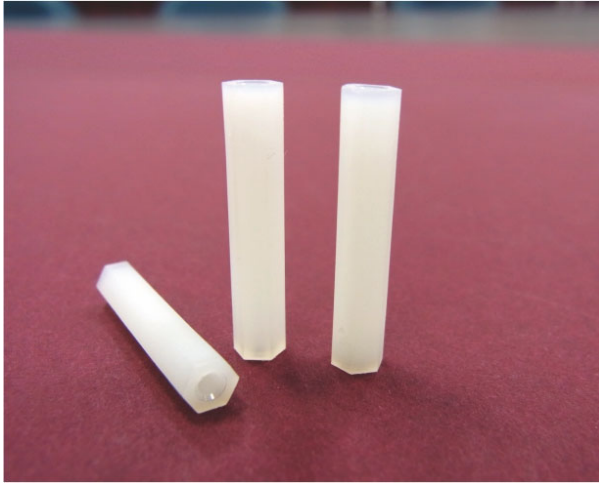

### 塑料铜柱

PART NO: KHPL-21

- ◆ MATERIAL: NYLON 66 (UL)
- ◆ FLAME CLASS :94V-2/94V-0
- ◆ COLOR: NATURAL
- ◆ UNIT: mm

用途: 做为 PC 板与机板间之固定,  
六角型不滑动。

KHPL-21 结构图

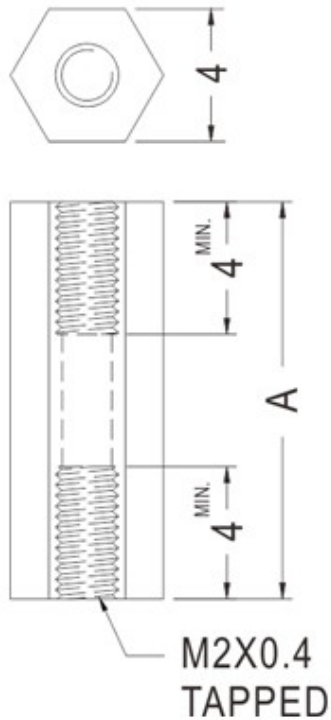

PART NO	A	PACKAGE
KHPL-21	20.0	1000

# 南京诺金电气有限公司

## Nanjing Nowking Electric Co., Ltd

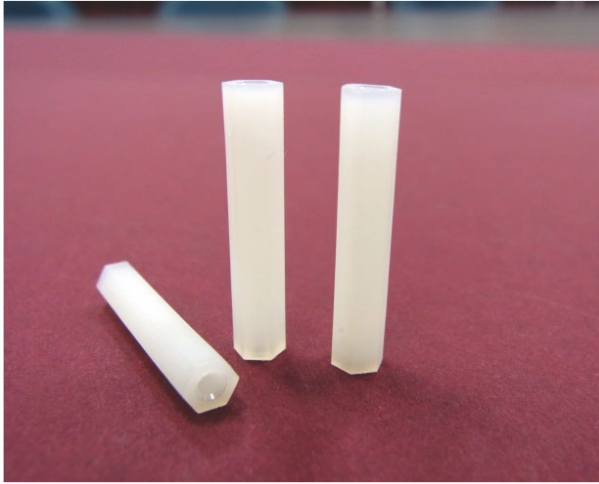

### 塑料铜柱

PART NO: KHPL-22

- ◆ MATERIAL: NYLON 66 (UL)
- ◆ FLAME CLASS :94V-2/94V-0
- ◆ COLOR: NATURAL
- ◆ UNIT: mm

用途: 做为 PC 板与机板间之固定,  
六角型不滑动。

KHPL-22 结构图

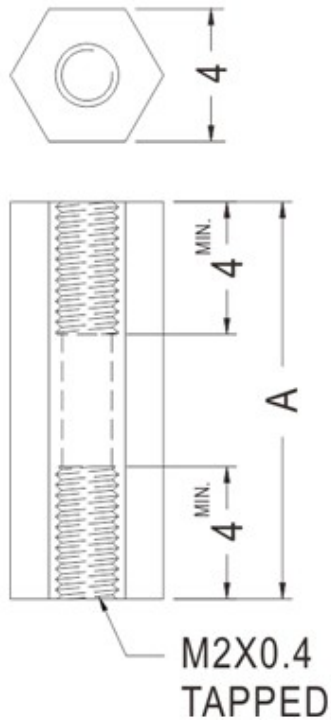

PART NO	A	PACKAGE
KHPL-22	21.0	1000

# 南京诺金电气有限公司

## Nanjing Nowking Electric Co., Ltd

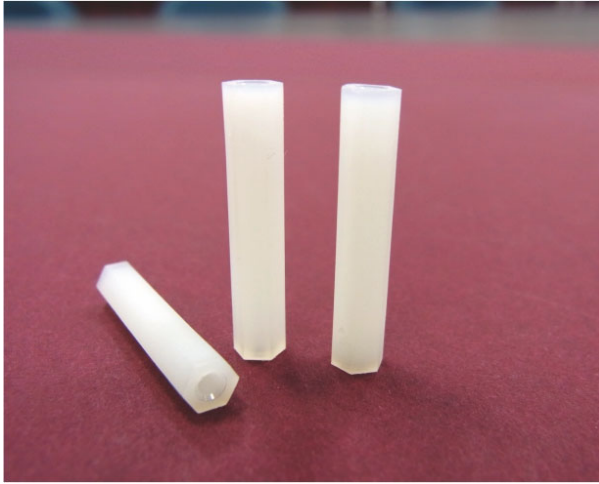

### 塑料铜柱

PART NO: KHPL-23

- ◆ MATERIAL: NYLON 66 (UL)
- ◆ FLAME CLASS :94V-2/94V-0
- ◆ COLOR: NATURAL
- ◆ UNIT: mm

用途: 做为 PC 板与机板间之固定,  
六角型不滑动。

KHPL-23 结构图

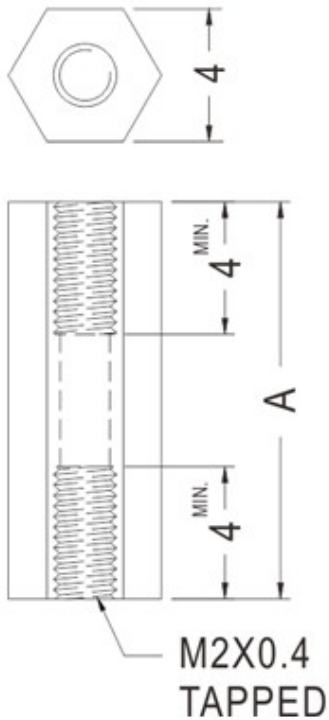

PART NO	A	PACKAGE
KHPL-23	22.0	1000

# 南京诺金电气有限公司

## Nanjing Nowking Electric Co., Ltd

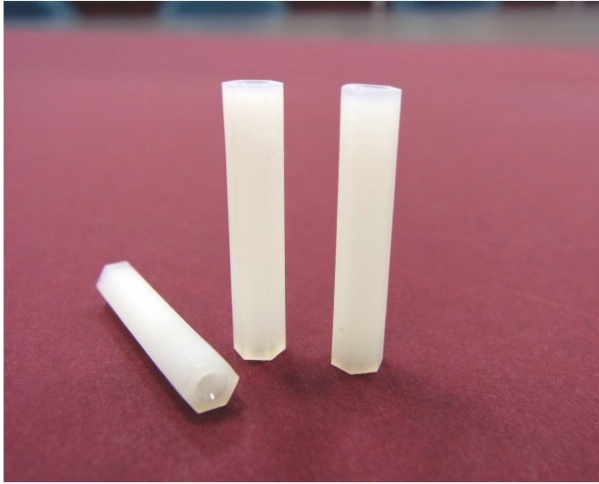

### 塑料铜柱

PART NO: KHPL-24

- ◆ MATERIAL: NYLON 66 (UL)
- ◆ FLAME CLASS :94V-2/94V-0
- ◆ COLOR: NATURAL
- ◆ UNIT: mm

用途: 做为 PC 板与机板间之固定,  
六角型不滑动。

KHPL-24 结构图

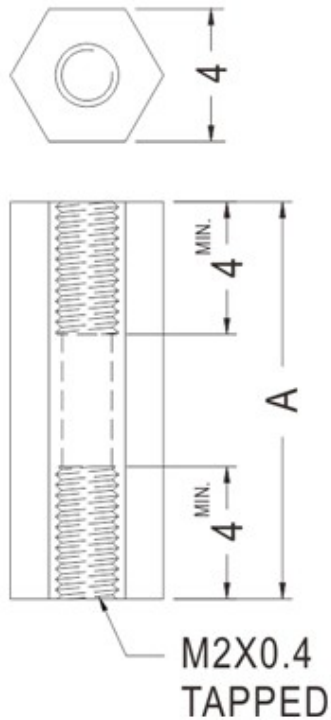

PART NO	A	PACKAGE
KHPL-24	23.0	1000



# 南京诺金电气有限公司

## Nanjing Nowking Electric Co., Ltd



### 塑料铜柱

PART NO: KHPL-25

- ◆ MATERIAL: NYLON 66 (UL)
- ◆ FLAME CLASS :94V-2/94V-0
- ◆ COLOR: NATURAL
- ◆ UNIT: mm

用途: 做为 PC 板与机板间之固定,  
六角型不滑动。

KHPL-25 结构图

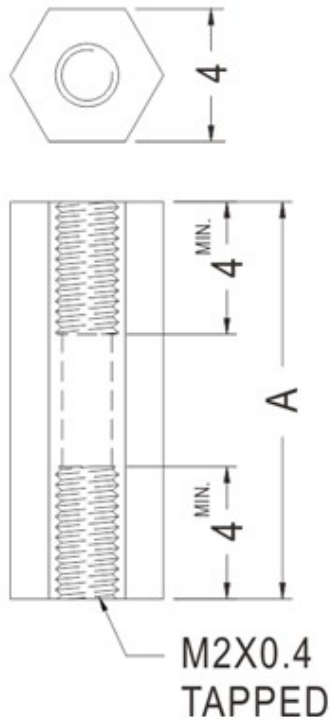

PART NO	A	PACKAGE
KHPL-25	24.0	1000

# 南京诺金电气有限公司

## Nanjing Nowking Electric Co., Ltd

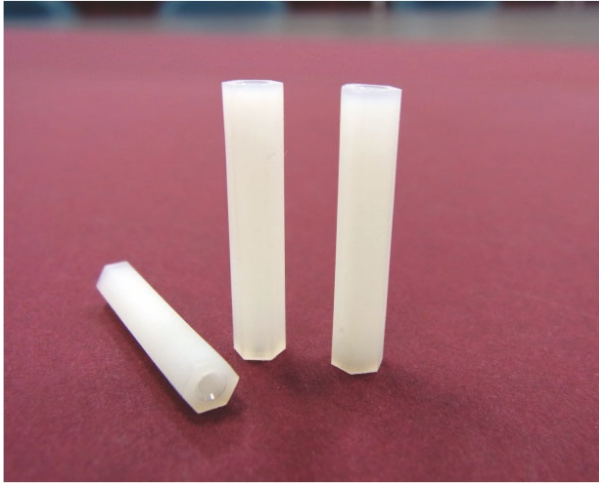

### 塑料铜柱

PART NO: KHPL-26

- ◆ MATERIAL: NYLON 66 (UL)
- ◆ FLAME CLASS :94V-2/94V-0
- ◆ COLOR: NATURAL
- ◆ UNIT: mm

用途: 做为 PC 板与机板间之固定,  
六角型不滑动。

KHPL-26 结构图

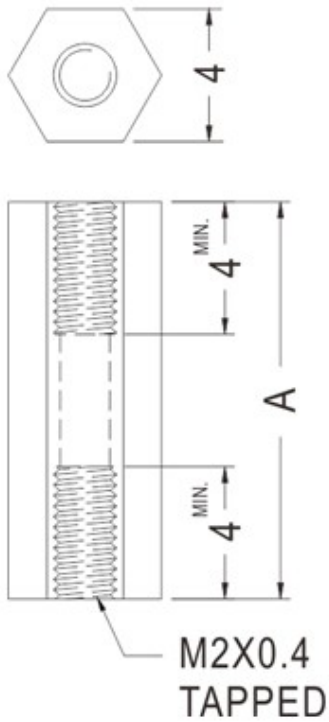

PART NO	A	PACKAGE
KHPL-26	25.0	1000

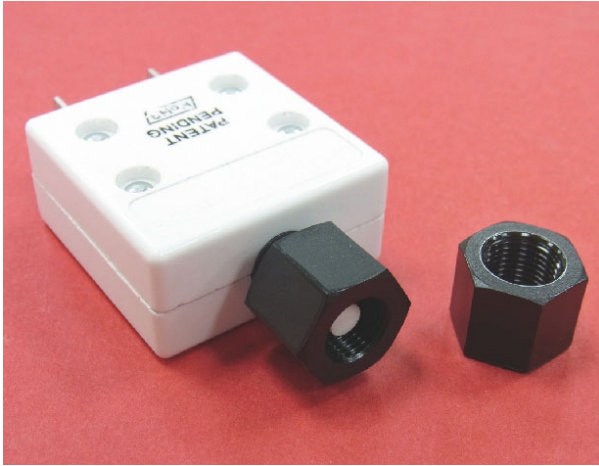

塑料铜柱

PART NO: KHPL-27

- ◆ MATERIAL: NYLON 66 (UL)
- ◆ FLAME CLASS: 94V-2
- ◆ COLOR: BLACK
- ◆ UNIT: mm

用途: 做为断路器保护, 避免误触。

KHPL-27 结构图

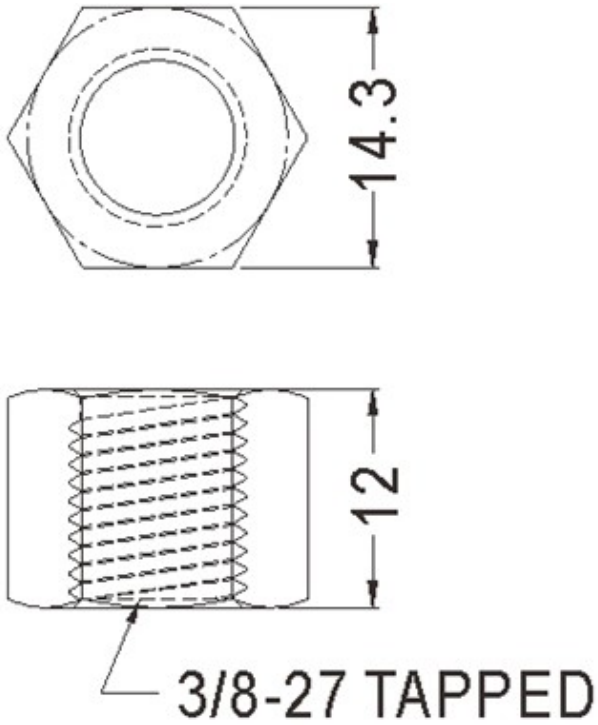

**PART NO**  
KHPL-27

**PACKAGE**  
1000

# 南京诺金电气有限公司

## Nanjing Nowking Electric Co., Ltd



### 塑料铜柱

PART NO: KHPL-28

- ◆ MATERIAL: NYLON 66 (UL)
- ◆ FLAME CLASS: 94V-2/94V-0
- ◆ COLOR: NATURAL/BLACK
- ◆ UNIT: mm

用途: 做为 PC 板与机板间之固定,  
六角型不滑动。

KHPL-28 结构图

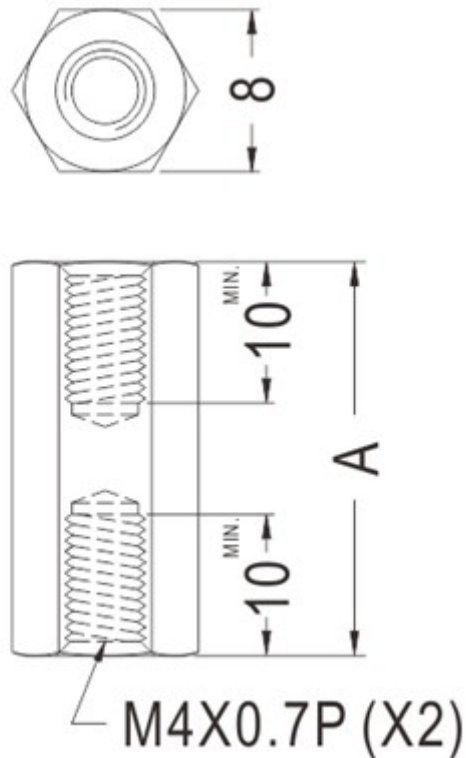

PART NO	A	PACKAGE
KHPL-28	35.0	1000

# 南京诺金电气有限公司

## Nanjing Nowking Electric Co., Ltd



### 塑料铜柱

PART NO: KHPL-29

- ◆ MATERIAL: NYLON 66 (UL)
- ◆ FLAME CLASS: 94V-2/94V-0
- ◆ COLOR: NATURAL/BLACK
- ◆ UNIT: mm

用途: 做为 PC 板与机板间之固定,  
六角型不滑动。

KHPL-29 结构图

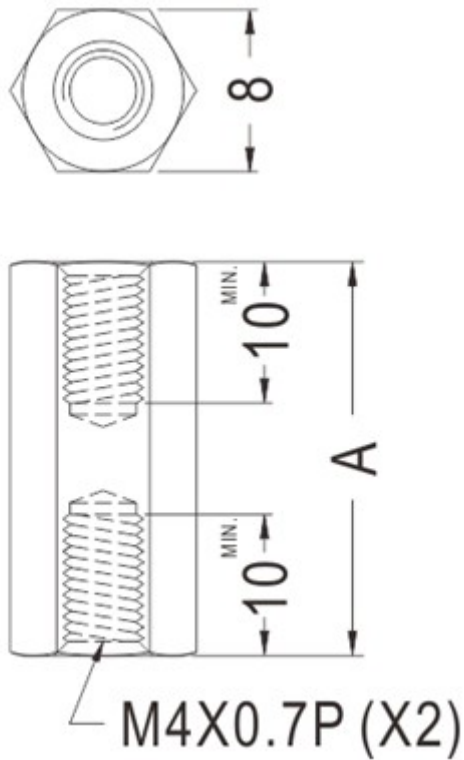

PART NO	A	PACKAGE
KHPL-29	40.0	1000

# 南京诺金电气有限公司

## Nanjing Nowking Electric Co., Ltd



### 塑料铜柱

PART NO: KHPL-30

- ◆ MATERIAL: NYLON 66 (UL)
- ◆ FLAME CLASS: 94V-2/94V-0
- ◆ COLOR: NATURAL
- ◆ UNIT: mm

用途: 做为 PC 板与机板间之固定,  
六角型不滑动。

KHPL-30 结构图

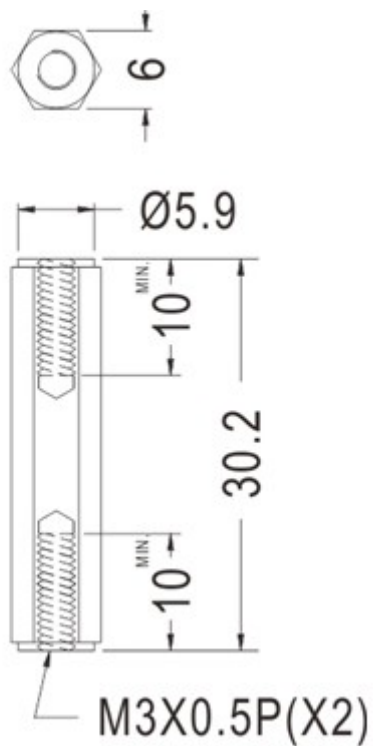

**PART NO**  
KHPL-30

**PACKAGE**  
1000