

南京诺金电气有限公司

Nanjing Nowking Electric Co., Ltd

电源线扣样本



产品名称：电源线扣

规格型号：DS-001

◆ MATERIAL: NYLON 66(UL)

◆ FLAME CLASS: 94V-2, 94V-0

◆ COLOR: BLACK

◆ UNIT: mm

用途：用于单芯电源线之连接，插入式，免
用胶带，方便，省时。

线径规格

CORD TYPE : SPT-1

SIZE : 18/2C

DS-001 结构图

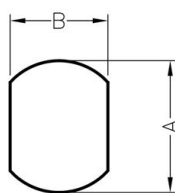
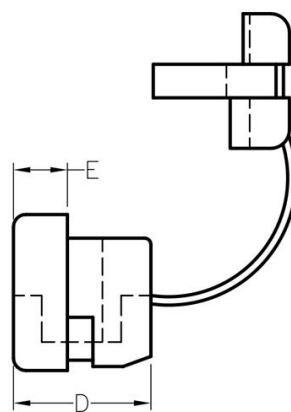
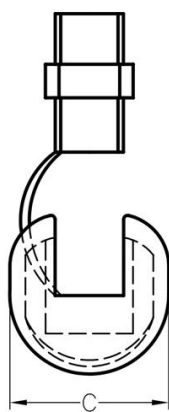

MOUNTING HOLE
CHASSIS THICKNESS F

PART NO	A	B	C	D	E	F	PACKAGE
DS-001	9.5	8.7	10.4	10.4	4.0	1.6	1000

(规格 / 尺寸) 代码说明：

A : 装配孔

B : 装配孔

F : 装配板厚

总机/TEL:+86 25 85422485 85437901 85436028

[Http://www.nowking.com](http://www.nowking.com) E-mail: nk@nowking.com

QQ: 260678075 微信: 13770725488

南京诺金电气有限公司

Nanjing Nowking Electric Co., Ltd



产品名称：电源线扣

规格型号：DS-002

- ◆ MATERIAL: NYLON 66(UL)
- ◆ FLAME CLASS: 94V-2, 94V-0
- ◆ COLOR: BLACK
- ◆ UNIT: mm

用途：用于单芯电源线之连接，插入式，免
用胶带，方便，省时。

线径规格

CORD TYPE : SPT-1

SIZE : 18/2C

DS-002 结构图

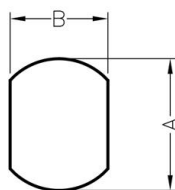
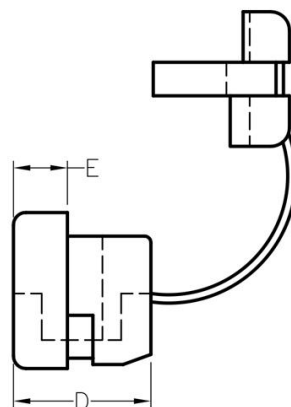
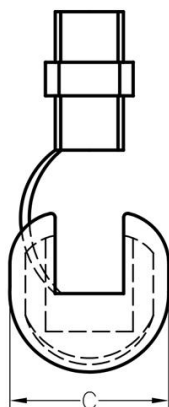

MOUNTING HOLE
CHASSIS THICKNESS F

PART NO	A	B	C	D	E	F	PACKAGE
DS-002	11.0	9.9	11.5	10.4	4.0	2.5	1000

(规格 / 尺寸) 代码说明：

- A : 装配孔
- B : 装配孔
- F : 装配板厚

南京诺金电气有限公司

Nanjing Nowking Electric Co., Ltd



产品名称：电源线扣

规格型号：DS-003

- ◆ MATERIAL: NYLON 66(UL)
- ◆ FLAME CLASS: 94V-2, 94V-0
- ◆ COLOR: BLACK
- ◆ UNIT: mm

用途：用于单芯电源线之连接，插入式，免胶带，方便，省时。

线径规格

CORD TYPE : SPT-1

SIZE : 18/2C

DS-003 结构图

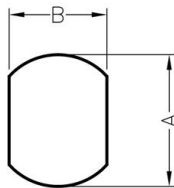
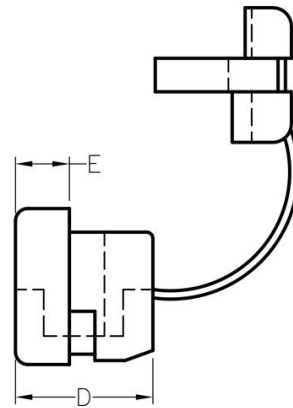
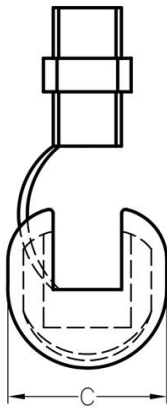

MOUNTING HOLE
CHASSIS THICKNESS F

PART NO	A	B	C	D	E	F	PACKAGE
DS-003	11.0	9.9	11.5	10.4	4.0	1.6	1000

(规格 / 尺寸) 代码说明：

- A : 装配孔
- B : 装配孔
- F : 装配板厚

南京诺金电气有限公司

Nanjing Nowking Electric Co., Ltd



产品名称：电源线扣

规格型号：DS-004

- ◆ MATERIAL: NYLON 66(UL)
- ◆ FLAME CLASS: 94V-2, 94V-0
- ◆ COLOR: BLACK
- ◆ UNIT: mm

用途：用于单芯电源线之连接，插入式，免
用胶带，方便，省时。

线径规格

CORD TYPE : SPT-2

SIZE : 18/2C

DS-004 结构图

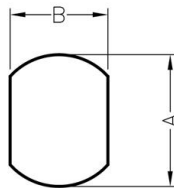
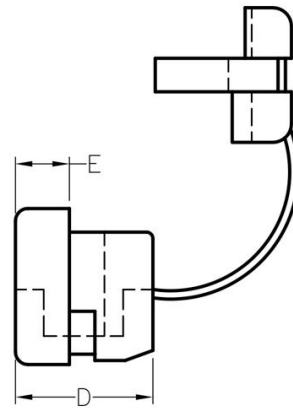
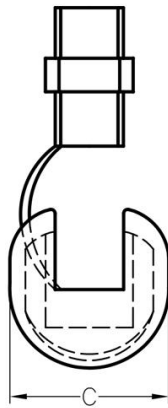

MOUNTING HOLE
CHASSIS THICKNESS F

PART NO	A	B	C	D	E	F	PACKAGE
DS-004	12.7	11.8	13.3	10.4	4.0	1.6	1000

(规格 / 尺寸) 代码说明：

- A : 装配孔
- B : 装配孔
- F : 装配板厚

南京诺金电气有限公司

Nanjing Nowking Electric Co., Ltd



产品名称：电源线扣

规格型号：DS-005

- ◆ MATERIAL: NYLON 66(UL)
- ◆ FLAME CLASS: 94V-2, 94V-0
- ◆ COLOR: BLACK
- ◆ UNIT: mm

用途：用于单芯电源线之连接，插入式，免
用胶带，方便，省时。

线径规格

CORD TYPE : SPT-2

SIZE : 18/2C

DS-005 结构图

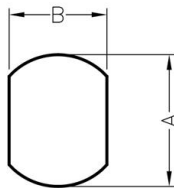
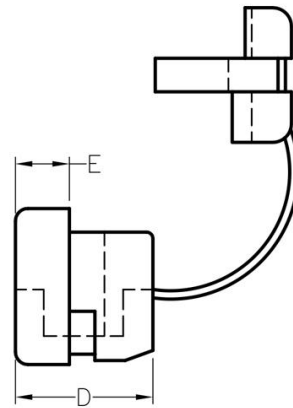
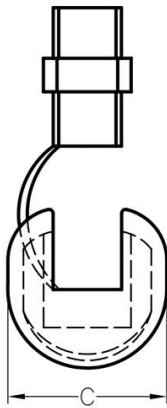

MOUNTING HOLE
CHASSIS THICKNESS F

PART NO	A	B	C	D	E	F	PACKAGE
DS-005	12.7 13.1	11.8	13.3	10.5	4.0	2.5	1000

(规格 / 尺寸) 代码说明：

- A : 装配孔
- B : 装配孔
- F : 装配板厚

南京诺金电气有限公司

Nanjing Nowking Electric Co., Ltd



产品名称：电源线扣

规格型号：DS-006

- ◆ MATERIAL: NYLON 66(UL)
- ◆ FLAME CLASS: 94V-2, 94V-0
- ◆ COLOR: BLACK
- ◆ UNIT: mm

用途：用于单芯电源线之连接，插入式，免
用胶带，方便，省时。

线径规格

CORD TYPE : SVT

SIZE : 18/3C

DS-006 结构图

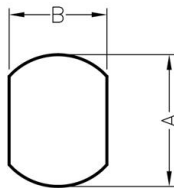
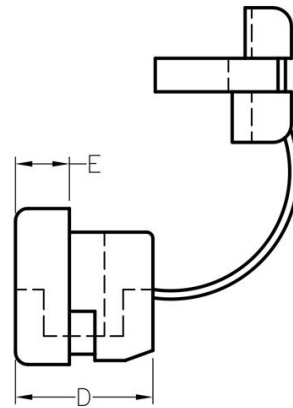
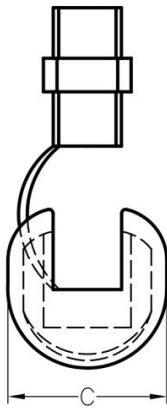

MOUNTING HOLE
CHASSIS THICKNESS F

PART NO	A	B	C	D	E	F	PACKAGE
DS-006	12.7 13.1	11.5	13.5	10.9	4.2	1.6	1000

(规格 / 尺寸) 代码说明：

- A : 装配孔
- B : 装配孔
- F : 装配板厚

南京诺金电气有限公司

Nanjing Nowking Electric Co., Ltd



产品名称：电源线扣

规格型号：DS-007

- ◆ MATERIAL: NYLON 66(UL)
- ◆ FLAME CLASS: 94V-2, 94V-0
- ◆ COLOR: BLACK
- ◆ UNIT: mm

用途：用于单芯电源线之连接，插入式，免
用胶带，方便，省时。

线径规格

CORD TYPE : SVT

SIZE : 18/3C

DS-007 结构图

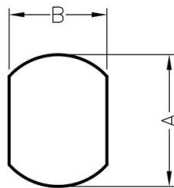
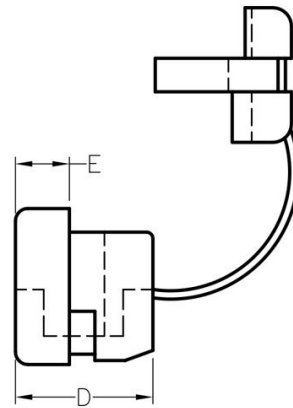
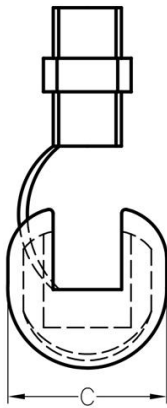

MOUNTING HOLE
CHASSIS THICKNESS F

PART NO	A	B	C	D	E	F	PACKAGE
DS-007	12.7 13.1	11.5	13.5	10.9	4.2	1.6	1000

(规格 / 尺寸) 代码说明：

- A : 装配孔
- B : 装配孔
- F : 装配板厚

南京诺金电气有限公司

Nanjing Nowking Electric Co., Ltd



产品名称：电源线扣

规格型号：DS-008

- ◆ MATERIAL: NYLON 66(UL)
- ◆ FLAME CLASS: 94V-2, 94V-0
- ◆ COLOR: BLACK
- ◆ UNIT: mm

用途：用于单芯电源线之连接，插入式，免
用胶带，方便，省时。

线径规格

CORD TYPE : SJT

SIZE : 18/3C

DS-008 结构图

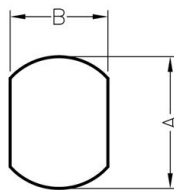
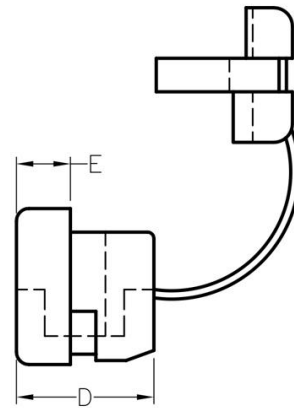
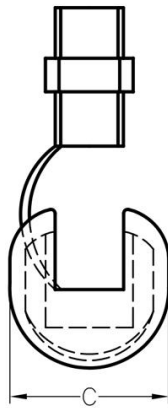

MOUNTING HOLE
CHASSIS THICKNESS F

PART NO	A	B	C	D	E	F	PACKAGE
DS-008	15.9	14.0	16.8	14.8	5.6	1.6	500

(规格 / 尺寸) 代码说明：

- A : 装配孔
- B : 装配孔
- F : 装配板厚

南京诺金电气有限公司

Nanjing Nowking Electric Co., Ltd



产品名称：电源线扣

规格型号：DS-009

- ◆ MATERIAL: NYLON 66(UL)
- ◆ FLAME CLASS: 94V-2, 94V-0
- ◆ COLOR: BLACK
- ◆ UNIT: mm

用途：用于单芯电源线之连接，插入式，免
用胶带，方便，省时。

线径规格

CORD TYPE : SJT

SIZE : 18/3C

DS-009 结构图

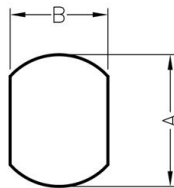
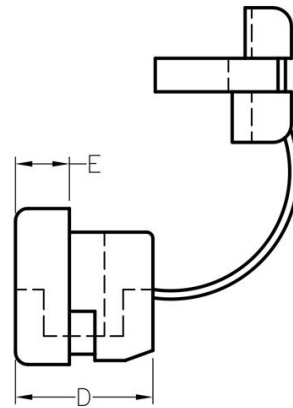
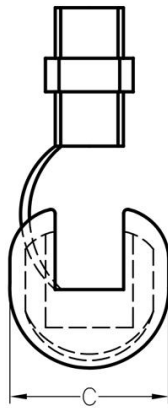

MOUNTING HOLE
CHASSIS THICKNESS F

PART NO	A	B	C	D	E	F	PACKAGE
DS-009	15.9	14.0	16.8	14.8	5.6	3.2	500

(规格 / 尺寸) 代码说明：

- A : 装配孔
- B : 装配孔
- F : 装配板厚

南京诺金电气有限公司

Nanjing Nowking Electric Co., Ltd



产品名称：电源线扣

规格型号：DS-010

- ◆ MATERIAL: NYLON 66(UL)
- ◆ FLAME CLASS: 94V-2, 94V-0
- ◆ COLOR: BLACK
- ◆ UNIT: mm

用途：用于单芯电源线之连接，插入式，免
用胶带，方便，省时。

线径规格

CORD TYPE : SJT

SIZE : 16/3C

DS-010 结构图

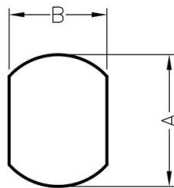
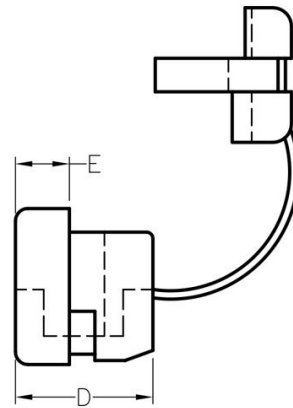
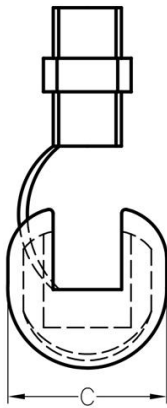

MOUNTING HOLE
CHASSIS THICKNESS F

PART NO	A	B	C	D	E	F	PACKAGE
DS-010	15.9	14.0	16.2	15.0	5.6	1.6	500

(规格 / 尺寸) 代码说明：

- A : 装配孔
- B : 装配孔
- F : 装配板厚

南京诺金电气有限公司

Nanjing Nowking Electric Co., Ltd



产品名称：电源线扣

规格型号：DS-011

- ◆ MATERIAL: NYLON 66(UL)
- ◆ FLAME CLASS: 94V-2, 94V-0
- ◆ COLOR: BLACK
- ◆ UNIT: mm

用途：用于单芯电源线之连接，插入式，免胶带，方便，省时。

线径规格

CORD TYPE : SJT

SIZE : 16/3C

DS-011 结构图

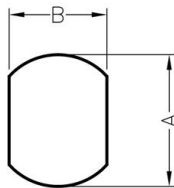
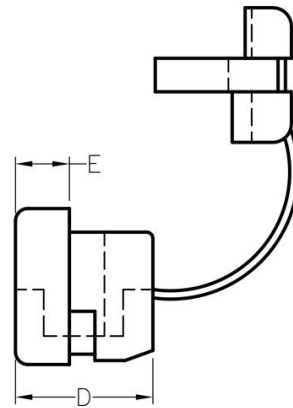
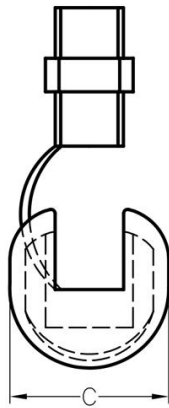

MOUNTING HOLE
CHASSIS THICKNESS F

PART NO	A	B	C	D	E	F	PACKAGE
DS-011	15.9	14.0	16.2	14.8	5.7	3.2	500

(规格 / 尺寸) 代码说明：

- A : 装配孔
- B : 装配孔
- F : 装配板厚

南京诺金电气有限公司

Nanjing Nowking Electric Co., Ltd



产品名称：电源线扣

规格型号：DS-012

- ◆ MATERIAL: NYLON 66(UL)
- ◆ FLAME CLASS: 94V-2, 94V-0
- ◆ COLOR: BLACK
- ◆ UNIT: mm

用途：用于单芯电源线之连接，插入式，免
用胶带，方便，省时。

线径规格

CORD TYPE : SJT

SIZE : 14/3C

DS-012 结构图

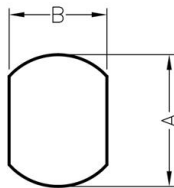
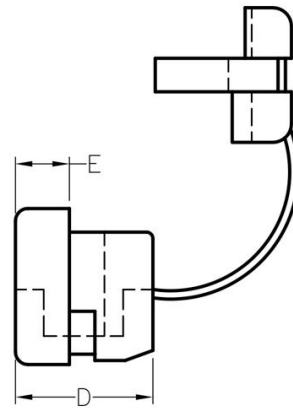
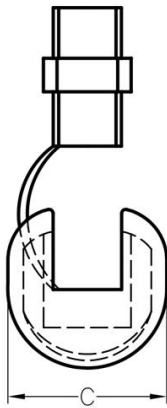

MOUNTING HOLE
CHASSIS THICKNESS F

PART NO	A	B	C	D	E	F	PACKAGE
DS-012	19.0 19.8	16.5	19.5	19.1	7.8	1.6	100

(规格 / 尺寸) 代码说明：

- A : 装配孔
- B : 装配孔
- F : 装配板厚

南京诺金电气有限公司

Nanjing Nowking Electric Co., Ltd



产品名称：电源线扣

规格型号：DS-013

- ◆ MATERIAL: NYLON 66(UL)
- ◆ FLAME CLASS: 94V-2, 94V-0
- ◆ COLOR: BLACK
- ◆ UNIT: mm

用途：用于单芯电源线之连接，插入式，免胶带，方便，省时。

线径规格

CORD TYPE : SJT

SIZE : 14/3C

DS-013 结构图

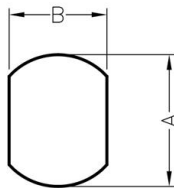
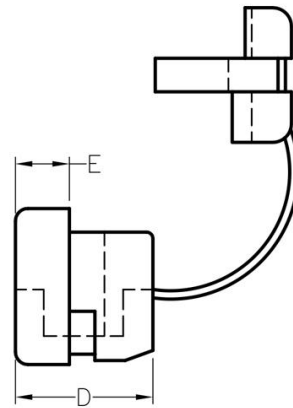
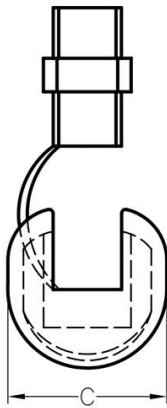

MOUNTING HOLE
CHASSIS THICKNESS F

PART NO	A	B	C	D	E	F	PACKAGE
DS-013	19.0 19.8	16.5	19.5	19.4	7.8	3.2	100

(规格 / 尺寸) 代码说明：

- A : 装配孔
- B : 装配孔
- F : 装配板厚

南京诺金电气有限公司

Nanjing Nowking Electric Co., Ltd



产品名称：电源线扣

规格型号：DS-014

- ◆ MATERIAL: NYLON 66(UL)
- ◆ FLAME CLASS: 94V-2, 94V-0
- ◆ COLOR: BLACK
- ◆ UNIT: mm

用途：用于电子电器电源出线口，固定扣牢和保护电源免于被机壳刮伤，造成短路。

线径规格

SIZE : $\varnothing 3.0 \sim 4.7$

DS-014 结构图

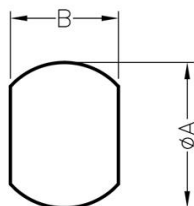
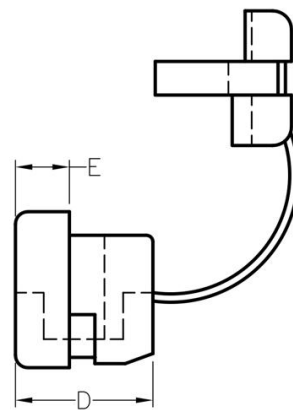
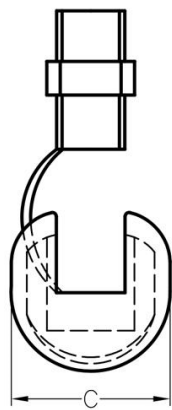

MOUNTING HOLE
CHASSIS THICKNESS F

PART NO	A	B	C	D	E	F	PACKAGE
DS-014	9.5	8.4	10.4	10.4	10.4	0.8~1.6	500

(规格 / 尺寸) 代码说明：

- A : 装配孔
- B : 装配孔
- F : 装配板厚

南京诺金电气有限公司

Nanjing Nowking Electric Co., Ltd

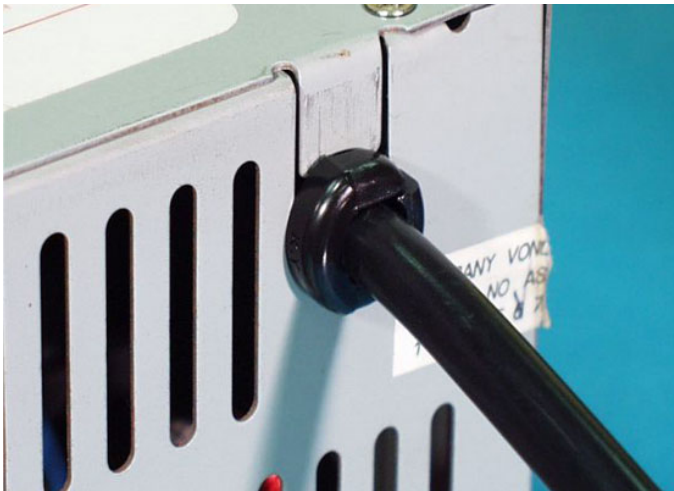

产品名称：电源线扣

规格型号：DS-015

- ◆ MATERIAL: NYLON 66(UL)
- ◆ FLAME CLASS: 94V-2, 94V-0
- ◆ COLOR: BLACK
- ◆ UNIT: mm

用途：用于机壳的电线出线口,保护电线不受机壳刮伤,装配容易。

线径规格

UL/CSA : SPT-2

SIZE : 4.1X8.6

DS-015 结构图

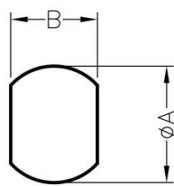
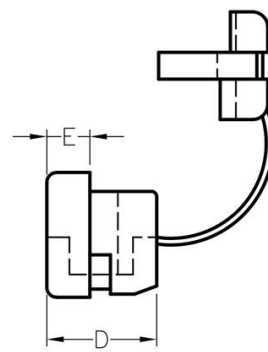
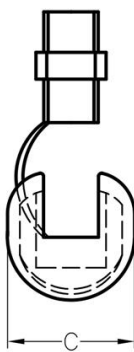

MOUNTING HOLE
CHASSIS THICKNESS F

PART NO	A	B	C	D	E	F	PACKAGE
DS-015	Ø12.7	11.8	14.0	12.4	4.0	1.8~2.5	500

(规格 / 尺寸) 代码说明：

- A : 装配孔
- B : 装配孔
- F : 装配板厚

南京诺金电气有限公司

Nanjing Nowking Electric Co., Ltd



产品名称：电源线扣

规格型号：DS-016

- ◆ MATERIAL: NYLON 66(UL)
- ◆ FLAME CLASS: 94V-2, 94V-0
- ◆ COLOR: BLACK
- ◆ UNIT: mm

用途：用于机壳的电线出线口, 保护电线不受机壳刮伤, 装配容易。

线径规格

UL/CSA : SJT3C#16

SIZE : Ø8.2~Ø9.2

DS-016 结构图

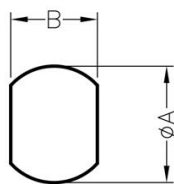
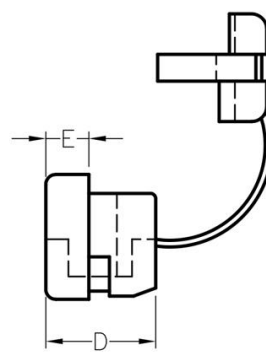
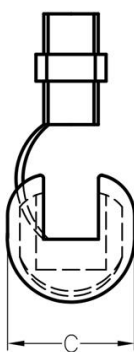

MOUNTING HOLE
CHASSIS THICKNESS F

PART NO	A	B	C	D	E	F	PACKAGE
DS-016	Ø12.7	11.5	14.0	11.5	4.8	0.8~1.6	500

(规格 / 尺寸) 代码说明：

A : 装配孔

B : 装配孔

F : 装配板厚

总机/TEL:+86 25 85422485 85437901 85436028

[Http://www.nowking.com](http://www.nowking.com) E-mail: nk@nowking.com

QQ: 260678075 微信: 13770725488

南京诺金电气有限公司

Nanjing Nowking Electric Co., Ltd



产品名称：电源线扣

规格型号：DS-017

- ◆ MATERIAL: NYLON 66(UL)
- ◆ FLAME CLASS: 94V-2, 94V-0
- ◆ COLOR: BLACK
- ◆ UNIT: mm

用途：用于机壳的电线出线口,保护电线不受机壳刮伤,装配容易。

线径规格

UL/CSA : SPT-3

SIZE : 5.0X10.0

DS-017 结构图

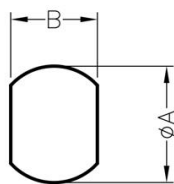
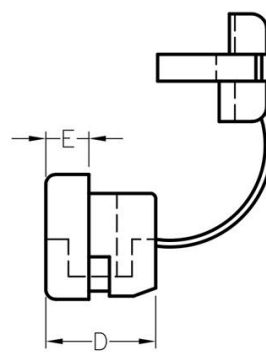
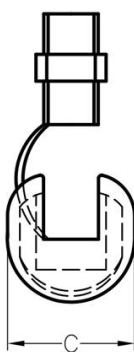

MOUNTING HOLE
CHASSIS THICKNESS F

PART NO	A	B	C	D	E	F	PACKAGE
DS-017	Ø14.3	13.4	15.5	15.4	6.2	0.8~1.6	250

(规格 / 尺寸) 代码说明：

A : 装配孔

B : 装配孔

F : 装配板厚

总机/TEL:+86 25 85422485 85437901 85436028

[Http://www.nowking.com](http://www.nowking.com) E-mail: nk@nowking.com

QQ: 260678075 微信: 13770725488

南京诺金电气有限公司

Nanjing Nowking Electric Co., Ltd

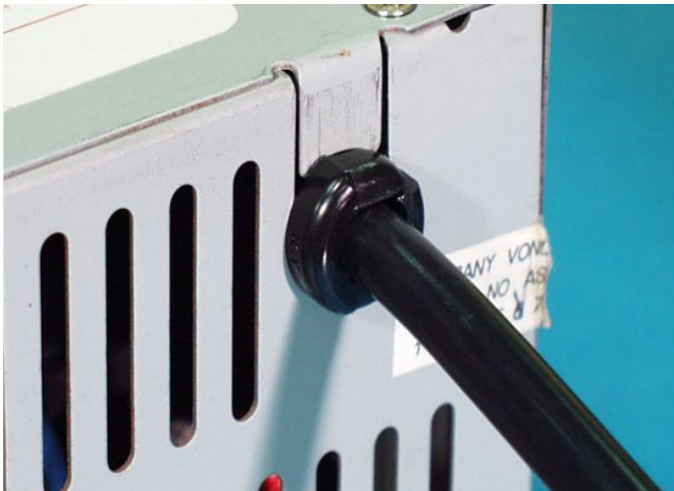

产品名称：电源线扣

规格型号：DS-018

- ◆ MATERIAL: NYLON 66(UL)
- ◆ FLAME CLASS: 94V-2, 94V-0
- ◆ COLOR: BLACK
- ◆ UNIT: mm

用途：用于机壳的电线出线口,保护电线不受机壳刮伤,装配容易。

线径规格

UL/CSA : SJT3C#16

SIZE : Ø8.2~Ø9.2

DS-018 结构图

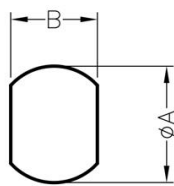
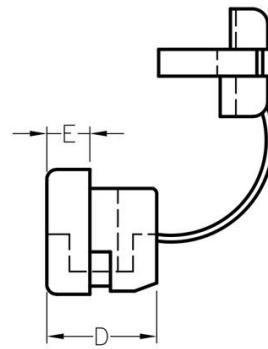
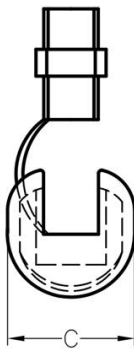

MOUNTING HOLE
CHASSIS THICKNESS F

PART NO	A	B	C	D	E	F	PACKAGE
DS-018	Ø15.9	14.0	16.6	14.6	5.6	0.8~1.6	250

(规格 / 尺寸) 代码说明：

A : 装配孔

B : 装配孔

F : 装配板厚

南京诺金电气有限公司

Nanjing Nowking Electric Co., Ltd

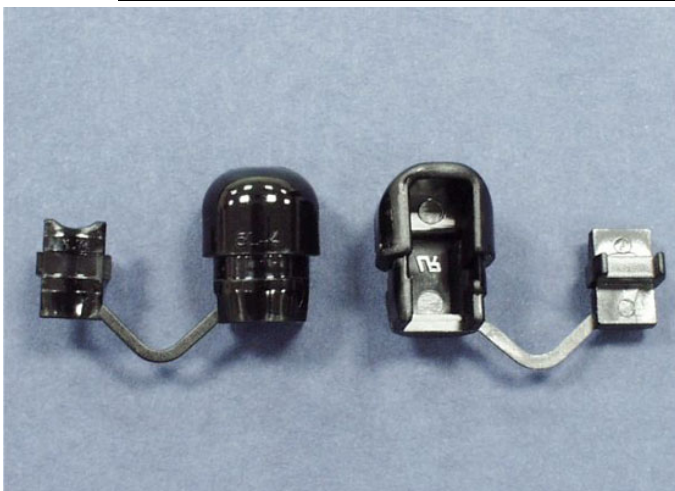

产品名称：电源线扣

规格型号：DS-019

◆ MATERIAL: NYLON 66(UL)

◆ FLAME CLASS: 94V-2, 94V-0

◆ COLOR: BLACK

◆ UNIT: mm

用途：用于交换式电源供应器出线口保护和固定电线。

线径规格

UL/CSA : SPT-2

SIZE : 3X6.6

DS-019 结构图

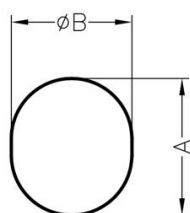
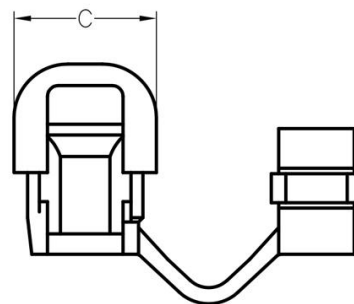
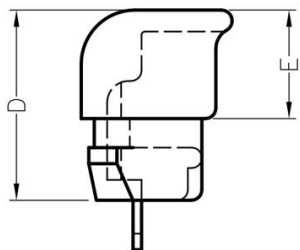

MOUNTING HOLE
CHASSIS THICKNESS F

PART NO	A	B	C	D	E	F	PACKAGE
DS-019	12.7	11.2	13.2	17.7	10.1	2.5	500

(规格 / 尺寸) 代码说明：

A : 装配孔

B : 装配孔

F : 装配板厚

总机/TEL:+86 25 85422485 85437901 85436028

[Http://www.nowking.com](http://www.nowking.com) E-mail: nk@nowking.com

QQ: 260678075 微信: 13770725488

南京诺金电气有限公司

Nanjing Nowking Electric Co., Ltd

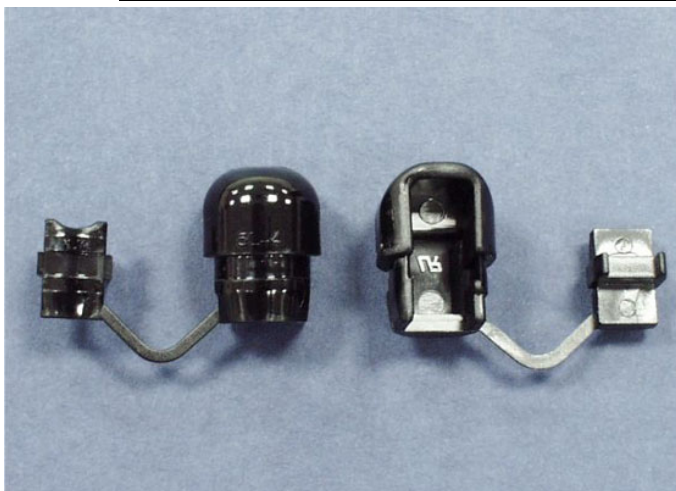

产品名称：电源线扣

规格型号：DS-020

◆ MATERIAL: NYLON 66(UL)

◆ FLAME CLASS: 94V-2, 94V-0

◆ COLOR: BLACK

◆ UNIT: mm

用途：用于交换式电源供应器出线口保护和固定电线。

线径规格

UL/CSA : SV

SIZE : 6.0

DS-020 结构图

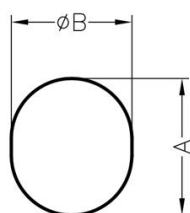
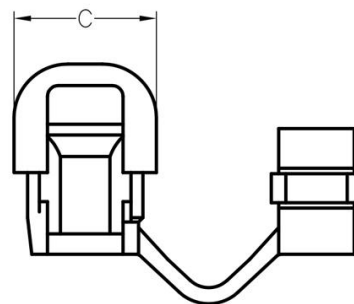
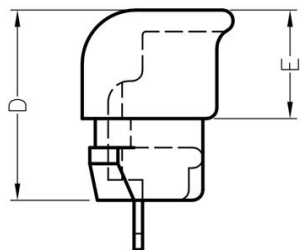

MOUNTING HOLE
CHASSIS THICKNESS F

PART NO	A	B	C	D	E	F	PACKAGE
DS-020	12.7	11.2	13.2	17.7	10.1	2.5	500

(规格 / 尺寸) 代码说明：

A : 装配孔

B : 装配孔

F : 装配板厚

总机/TEL:+86 25 85422485 85437901 85436028

[Http://www.nowking.com](http://www.nowking.com) E-mail: nk@nowking.com

QQ: 260678075 微信: 13770725488

南京诺金电气有限公司

Nanjing Nowking Electric Co., Ltd



产品名称：电源线扣

规格型号：DS-021

- ◆ MATERIAL: NYLON 66(UL)
- ◆ FLAME CLASS: 94V-2, 94V-0
- ◆ COLOR: BLACK
- ◆ UNIT: mm

用途：用于机壳的电线出线口, 保护电线不受机壳刮伤, 装配容易。

线径规格

UL/CSA : SJT3C#18

SIZE : $\phi 7.6$

DS-021 结构图

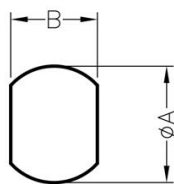
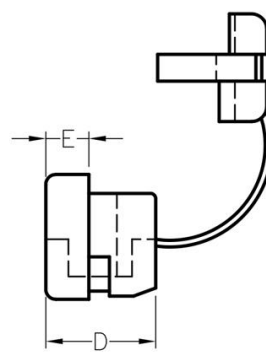
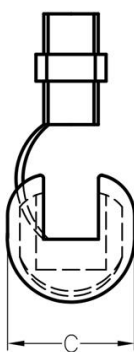

MOUNTING HOLE
CHASSIS THICKNESS F

PART NO	A	B	C	D	E	F	PACKAGE
DS-021	$\phi 12.7$	11.5	13.4	10.9	4.2	0.8~1.6	500

(规格 / 尺寸) 代码说明：

A : 装配孔

B : 装配孔

F : 装配板厚

南京诺金电气有限公司

Nanjing Nowking Electric Co., Ltd



产品名称：电源线扣

规格型号：DS-022

- ◆ MATERIAL: NYLON 66(UL)
- ◆ FLAME CLASS: 94V-2, 94V-0
- ◆ COLOR: BLACK
- ◆ UNIT: mm

用途：用于交换式电源供应器出线口保护和固定电线。

线径规格

CORD TYPE: SJT

SIZE : 18/3C

DS-022 结构图

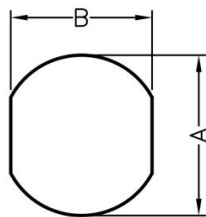
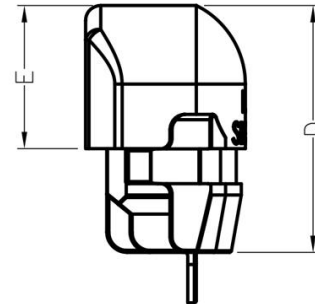
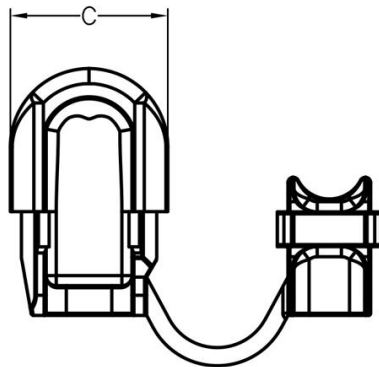

MOUNTING HOLE
CHASSIS THICKNESS F

PART NO	A	B	C	D	E	F	PACKAGE
DS-022	15.9	14.0	15.4	14.2	24.5	3.2	100

(规格 / 尺寸) 代码说明：

A : 装配孔

B : 装配孔

F : 装配板厚

南京诺金电气有限公司

Nanjing Nowking Electric Co., Ltd



产品名称：电源线扣

规格型号：DS-023

- ◆ MATERIAL: NYLON 66(UL)
- ◆ FLAME CLASS: 94V-2, 94V-0
- ◆ COLOR: BLACK
- ◆ UNIT: mm

用途：用于交换式电源供应器出线口保护和固定电线。

线径规格

CORD TYPE: SJT

SIZE : 14/3C

DS-023 结构图

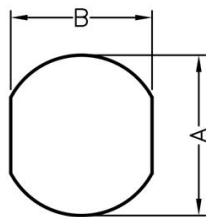
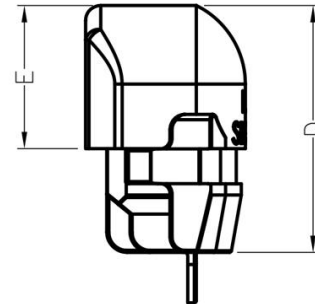
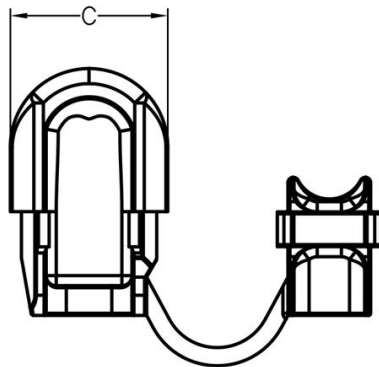

MOUNTING HOLE
CHASSIS THICKNESS F

PART NO	A	B	C	D	E	F	PACKAGE
DS-023	15.9	14.0	15.4	14.2	24.5	3.2	100

(规格 / 尺寸) 代码说明：

- A : 装配孔
- B : 装配孔
- F : 装配板厚

南京诺金电气有限公司

Nanjing Nowking Electric Co., Ltd

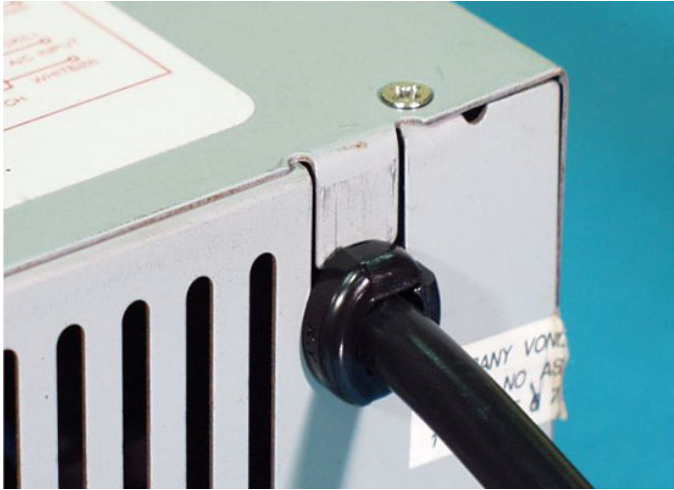

产品名称：电源线扣

规格型号：DS-024

- ◆ MATERIAL: NYLON 66(UL)
- ◆ FLAME CLASS: 94V-2, 94V-0
- ◆ COLOR: BLACK
- ◆ UNIT: mm

用途：用于交换式电源供应器出线口保护和固定电线。

线径规格

UL/CSA: SJT3C#14 #18 24~30PCS

SIZE : ∅12~15.2

DS-024 结构图

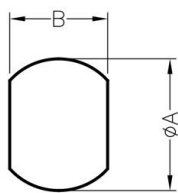
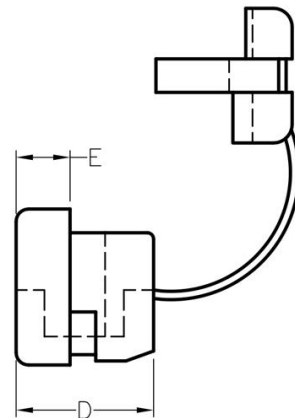
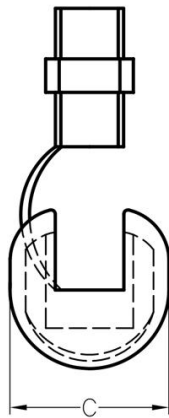

MOUNTING HOLE
CHASSIS THICKNESS F

PART NO	A	B	C	D	E	F	PACKAGE
DS-024	22.0	21.7	22.6	20.4	8.4	1.8~2.5	100

(规格 / 尺寸) 代码说明：

- A : 装配孔
- B : 装配孔
- F : 装配板厚

南京诺金电气有限公司

Nanjing Nowking Electric Co., Ltd

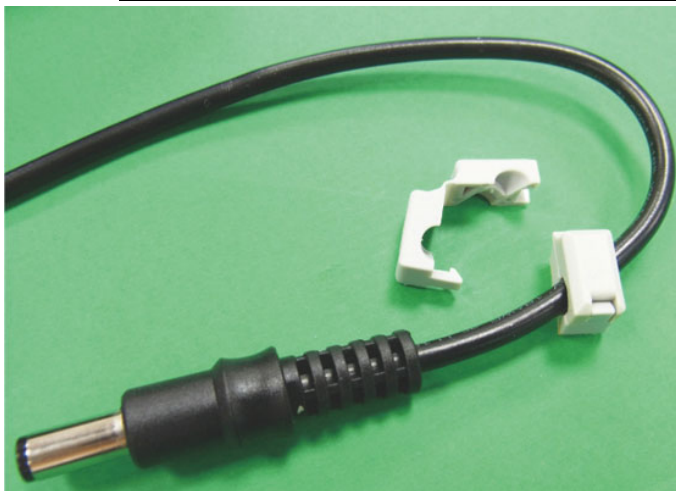

产品名称：电源线扣

规格型号：DS-025

- ◆ MATERIAL: NYLON 66(UL)
- ◆ FLAME CLASS: 94V-2, 94V-0
- ◆ COLOR: BLACK, GRAY, NATURAL
- ◆ UNIT: mm

用途：用于机壳的电线出线口，保护电线不受机壳刮伤，装配容易。

DS-025 结构图

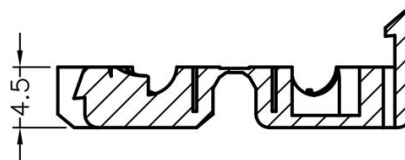
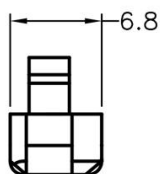

SECTION A-A

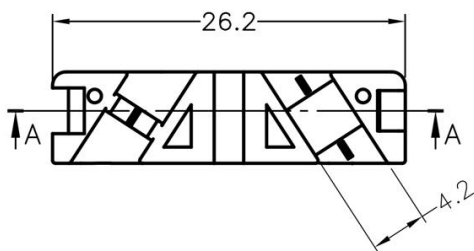

PART NO	PACKAGE
DS-025	100

(规格 / 尺寸) 代码说明：

- A : 装配孔
- B : 装配孔
- F : 装配板厚

南京诺金电气有限公司

Nanjing Nowking Electric Co., Ltd



产品名称：电源线扣

规格型号：DS-026

- ◆ MATERIAL: NYLON 66(UL)
- ◆ FLAME CLASS: 94V-2, 94V-0
- ◆ COLOR: BLACK
- ◆ UNIT: mm

用途：用于交换式电源供应器出线口保护和固定电线。

线径规格

UL/CSA: SJT3C#14 #18 24~30PCS

SIZE : ∅12~15.2

DS-026 结构图

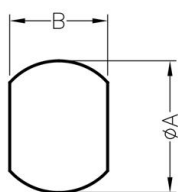
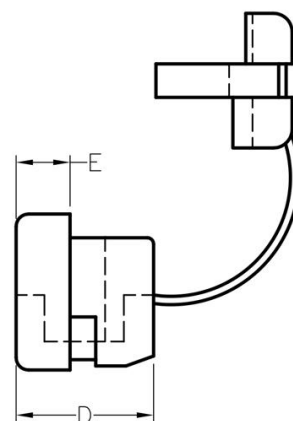
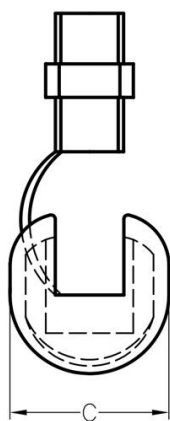

MOUNTING HOLE
CHASSIS THICKNESS F

PART NO	A	B	C	D	E	F	PACKAGE
DS-026	28.0	25.4	27.5	25.2	10.6	1.2~7.0	100

(规格 / 尺寸) 代码说明：

- A : 装配孔
- B : 装配孔
- F : 装配板厚

南京诺金电气有限公司

Nanjing Nowking Electric Co., Ltd



产品名称：电源线扣

规格型号：DS-027

- ◆ MATERIAL: NYLON 66(UL)
- ◆ FLAME CLASS: 94V-2, 94V-0
- ◆ COLOR: BLACK
- ◆ UNIT: mm

用途：用于机壳的电线出线口,保护电线不受机壳刮伤,装配容易。

线径规格

UL/CSA : SPT-2

SIZE : 4.1X8.6

DS-027 结构图

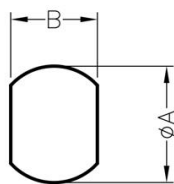
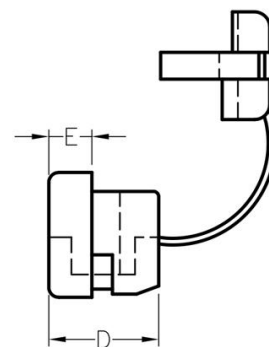
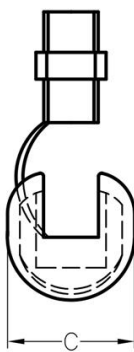

MOUNTING HOLE
CHASSIS THICKNESS F

PART NO	A	B	C	D	E	F	PACKAGE
DS-027	Ø12.7	11.8	14.0	12.5	4.4	0.8~2.6	500

(规格 / 尺寸) 代码说明：

- A : 装配孔
- B : 装配孔
- F : 装配板厚

南京诺金电气有限公司

Nanjing Nowking Electric Co., Ltd



产品名称：电源线扣

规格型号：DS-028

- ◆ MATERIAL: NYLON 66(UL)
- ◆ FLAME CLASS: 94V-2, 94V-0
- ◆ COLOR: BLACK
- ◆ UNIT: mm

用途：用于机壳的电线出线口, 保护电线不受机壳刮伤, 装配容易。

线径规格

UL/CSA : SPT-3

SIZE : 5.0X10.0

DS-028 结构图

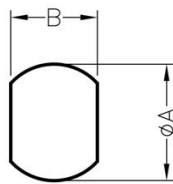
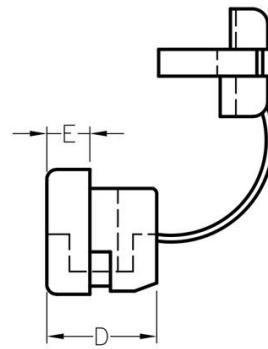
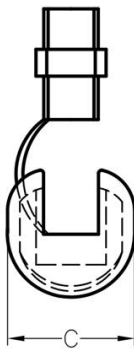

MOUNTING HOLE
CHASSIS THICKNESS F

PART NO	A	B	C	D	E	F	PACKAGE
DS-028	Ø14.3	13.4	15.5	15.4	6.2	1.8~3.2	250

(规格 / 尺寸) 代码说明：

- A : 装配孔
- B : 装配孔
- F : 装配板厚