

1394 防尘盖系列



1394 防尘盖

PART NO: 1394-001

◆ MATERIAL: PE

◆ COLOR: BLACK/DARK GRAY

◆ UNIT: mm

用途: 用于 1394 接头防尘与保护。

1394-001 结构图

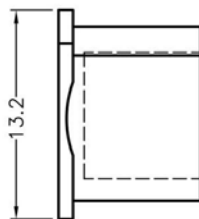
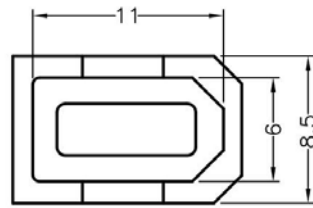
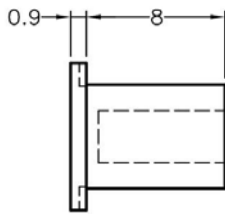

	PART NO	PACKAGE
	1394-001	1000

# 南京诺金电气有限公司

## Nanjing Nowking Electric Co., Ltd



### 1394 防尘盖

PART NO: 1394-002

◆ MATERIAL:PP(UL)

◆ COLOR:GRAY

◆ FLAME CLASS:94HB

◆ UNIT:mm

用途：用于 1394 接头防尘与保护。

附注： 所有尺寸量测皆不含进胶口,胶口凸出 0.3mm 之内.

1394-002 结构图:

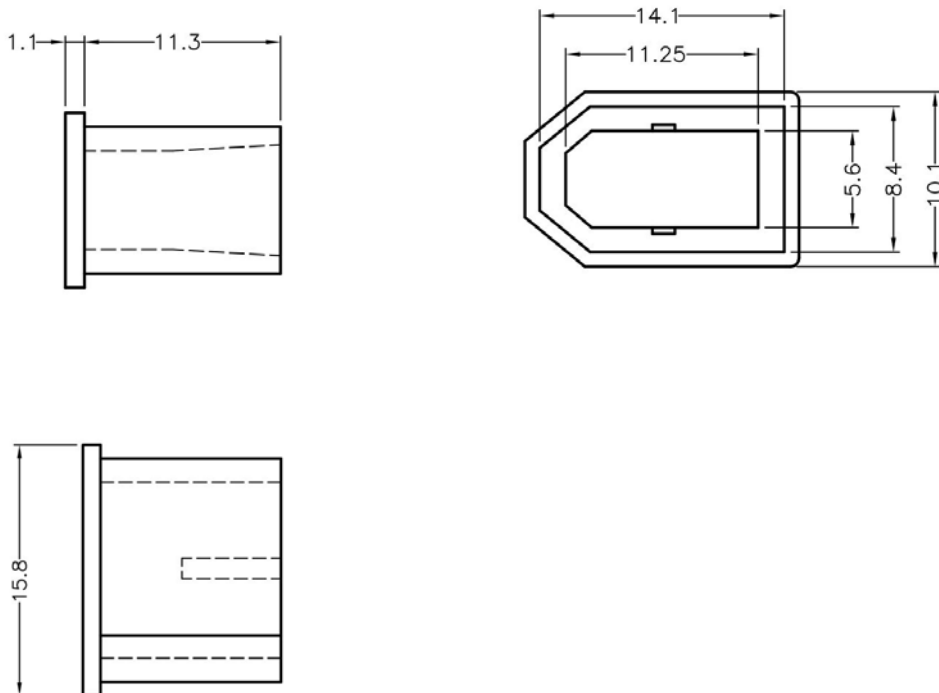

	PART NO	PACKAGE
	1394-002	1000



### 1394 防尘盖

PART NO: 1394-003

◆ MATERIAL:PP(UL)

◆ COLOR:GRAY

◆ FLAME CLASS:94V-2

◆ UNIT:mm

用途：用于 1394 接头防尘与保护。

附注： 所有尺寸量测皆不含进胶口,胶口凸出 0.3mm 之内.

1394-003 结构图:

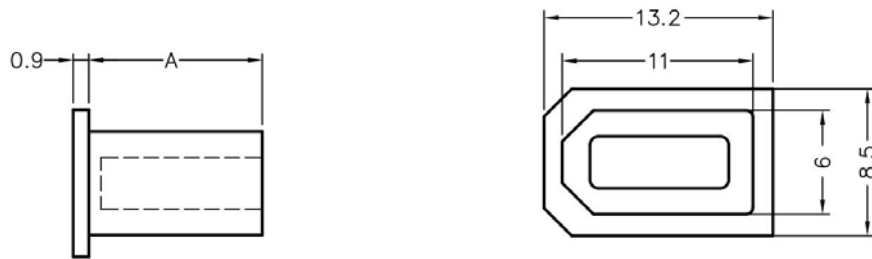

	PART NO	A	PACKAGE
	1394-003	10.0	1000



### 1394 防尘盖

PART NO: 1394-004

◆ MATERIAL:PP(UL)

◆ COLOR:GRAY

◆ FLAME CLASS:94V-2

◆ UNIT:mm

用途：用于 1394 接头防尘与保护。

附注： 所有尺寸量测皆不含进胶口,胶口凸出 0.3mm 之内.

1394-004 结构图:

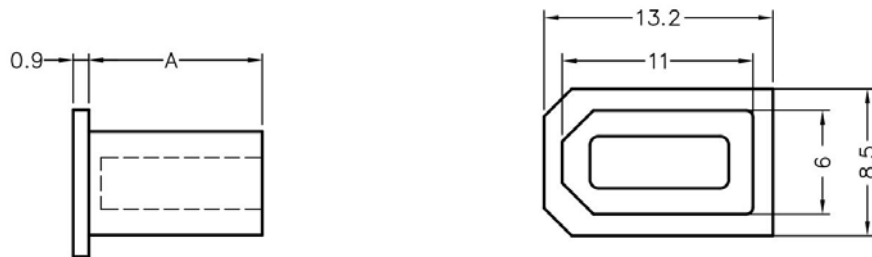

	PART NO	A	PACKAGE
	1394-004	11.5	1000

# 南京诺金电气有限公司

## Nanjing Nowking Electric Co., Ltd

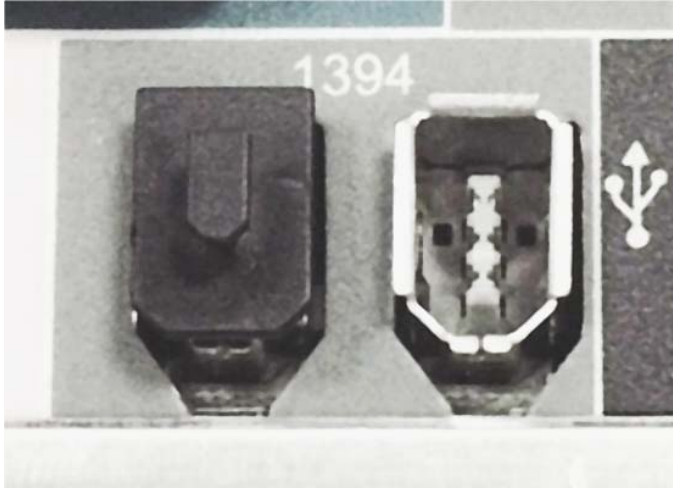

### 1394 防尘盖

PART NO: 1394-005

◆ MATERIAL: PE

◆ COLOR: BLACK/DARK GRAY

◆ UNIT: mm

用途: 用于 1394 接头防尘与保护。

1394-005 结构图:

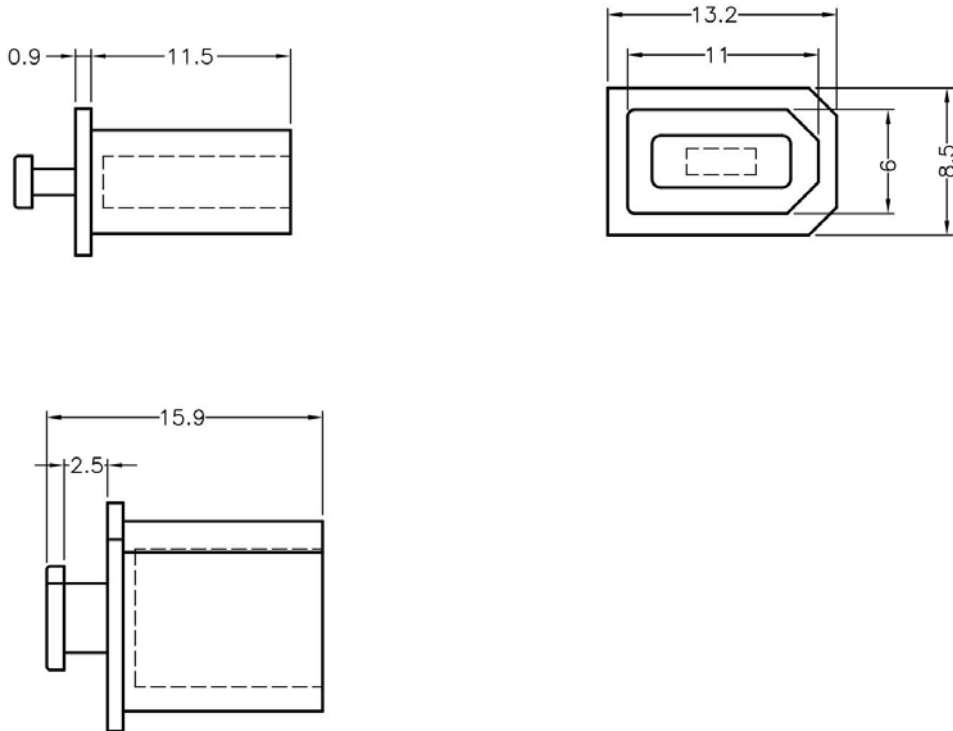

	PART NO	PACKAGE
	1394-005	1000

# 南京诺金电气有限公司

## Nanjing Nowking Electric Co., Ltd

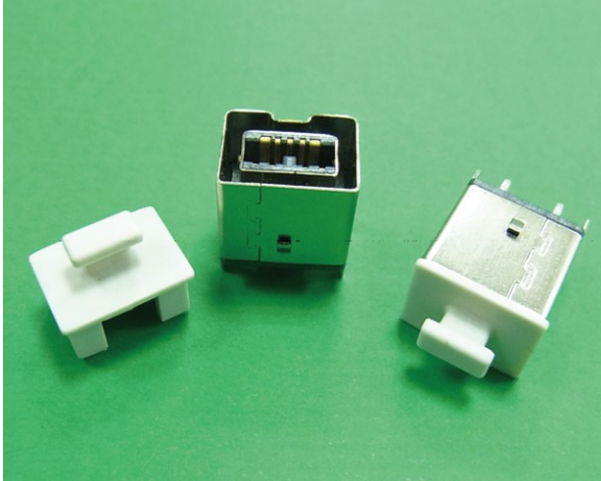

### 1394 防尘盖

PART NO: 1394-006

- ◆ MATERIAL: PE
- ◆ COLOR: BLACK/COMPUTER
- ◆ UNIT: mm

用途: 用于 1394 接头防尘与保护。

所有尺寸量测皆不含进胶口, 胶口凸出 0.3mm 之内

1394-006 结构图:

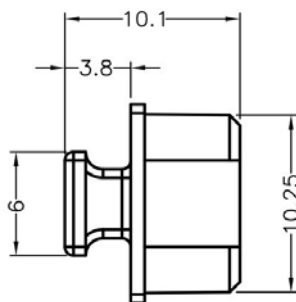
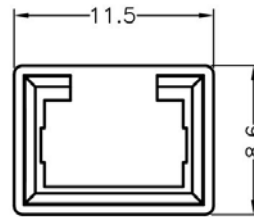
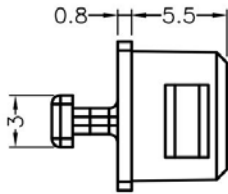

	PART NO	PACKAGE
	1394-006	1000