

PC板间隔柱 SPACER SUPPORT

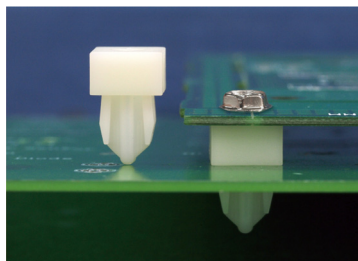

MATERIAL : NYLON 66(UL)
 FLAME CLASS : 94V-0,94V-2
 COLOR : BLACK,NATURAL
 UNIT: mm

用途 : 配合螺丝用于PC板之固定

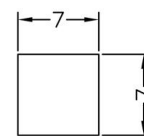
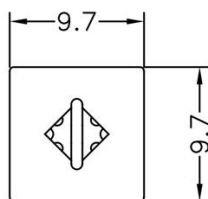
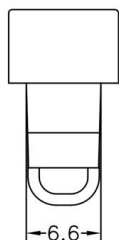
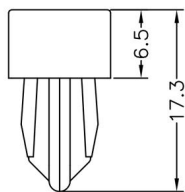

MOUNTING HOLE

PART NO	PACKAGE
PCSS-150	1000

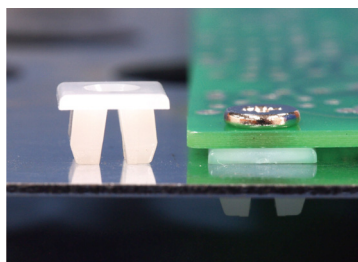

MATERIAL : NYLON 66(UL)
 FLAME CLASS : 94V-0,94V-2
 COLOR : BLACK,NATURAL
 UNIT: mm

用途 : 配合螺丝用于PC板之固定

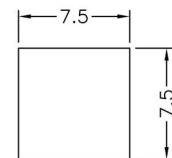

MOUNTING HOLE THICKNESS 2.4

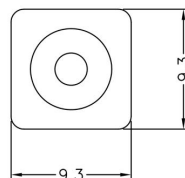
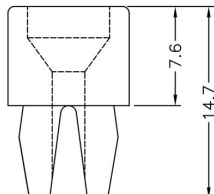

PART NO	PACKAGE
PCSS-151	1000

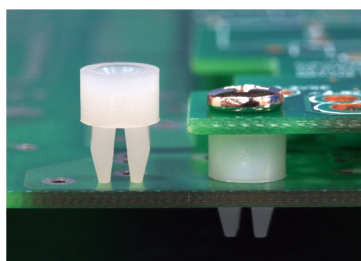

MATERIAL : NYLON 66(UL)
 FLAME CLASS : 94V-0,94V-2
 COLOR : BLACK,NATURAL
 UNIT: mm

用途 : 配合螺丝用于PC板之固定

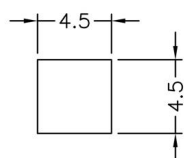

MOUNTING HOLE THICKNESS 2.0

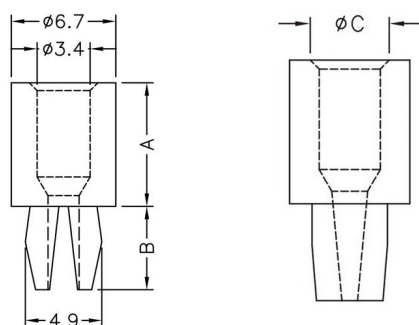

PART NO	A	B	C	PACKAGE
PCSS-152	3.0	5.4	Ø4.4	2000
PCSS-1391	3.0	5.4	Ø5.0	2000
PCSS-153	3.2	5.4	Ø4.4	2000
PCSS-1392	3.2	5.4	Ø5.0	2000
PCSS-154	3.4	5.4	Ø4.4	2000
PCSS-155	4.6	5.4	Ø4.4	2000
PCSS-156	4.8	5.4	Ø4.4	2000
PCSS-157	6.3	5.4	Ø4.4	1000
PCSS-158	6.5	4.0	Ø4.4	1000
PCSS-159	8.0	5.4	Ø4.4	1000
PCSS-160	10.0	5.4	Ø4.4	1000
PCSS-161	12.7	5.4	Ø4.4	1000
PCSS-162	15.9	5.4	Ø4.4	1000
PCSS-163	19.1	5.4	Ø4.4	1000
PCSS-1393	3.6	5.4	Ø5.0	2000

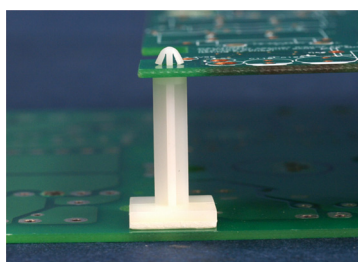

MATERIAL : NYLON 66(UL)
 FLAME CLASS : 94V-0,94V-2
 COLOR : BLACK,NATURAL
 UNIT: mm

用途 : 背胶式, 用于不能钻孔之机板与PC板间之固定。

高度不含背胶及离型纸厚度

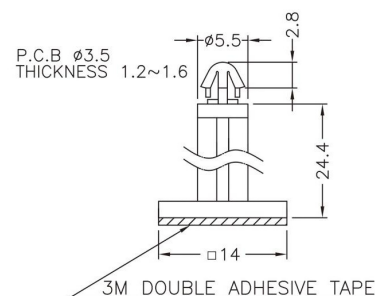

PART NO	PACKAGE
PCSS-164	1000