

LED间隔柱 LED SPACER SUPPORT

1

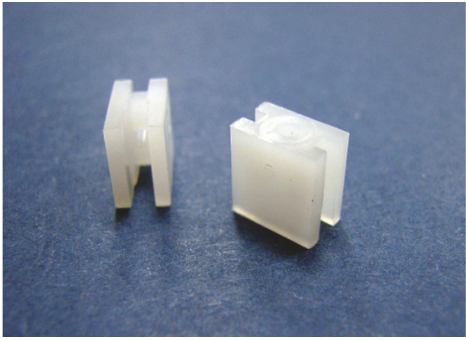

MATERIAL : NYLON 66(UL)
 FLAME CLASS : 94V-0,94V-2
 COLOR : BLACK,NATURAL
 UNIT : mm

用途：保护变色LED3PIN固定PC板上，使接脚不会弯曲、折断、短路，并使LED高度一致。

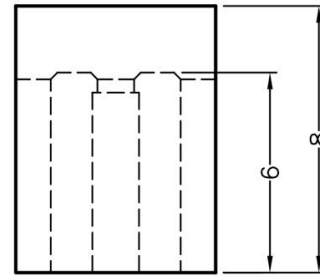
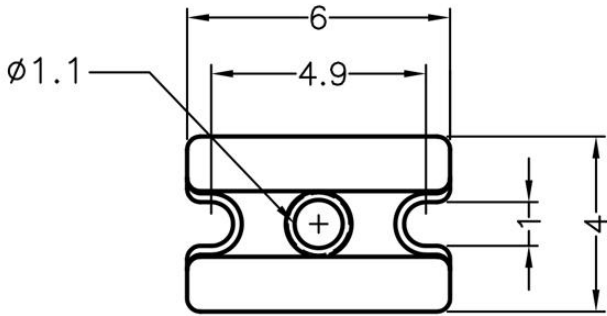

PART NO	P	PACKAGE
LEDSS-096	1	2000

(规格 / 尺寸) 代码说明：
 P : 装配灯数

LED间隔柱 LED SPACER SUPPORT

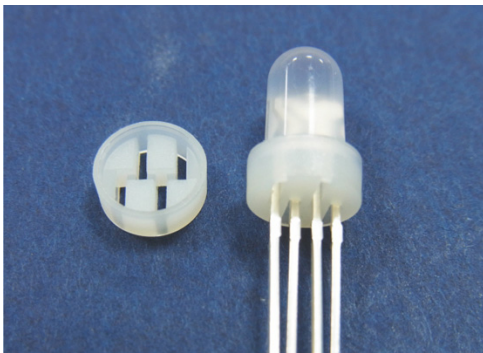

MATERIAL : NYLON 66(UL)
 FLAME CLASS : 94V-0,94V-2
 COLOR : BLACK,NATURAL
 UNIT : mm

用途：使4PIN变色LED固定于PC板上，高度一致，不断脚。

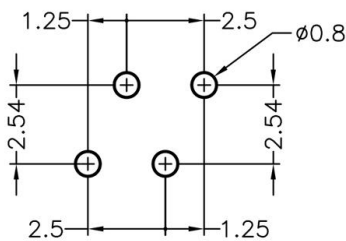
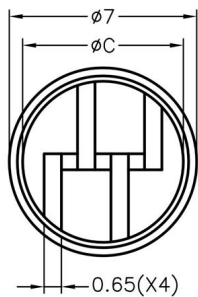

RECOMMEND MOUNTING HOLE

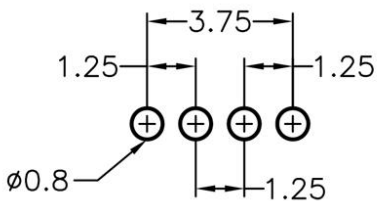
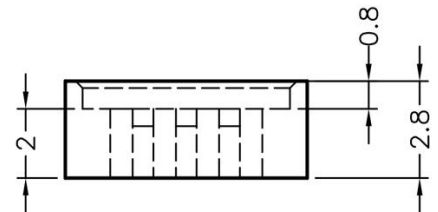

RECOMMEND MOUNTING HOLE

PART NO	C	L	P	PACKAGE
LEDSS-097	∅6.0	5.0	1	2000

(规格 / 尺寸) 代码说明：

L: LED建议装配柜台 P : 装配灯数